

**pH/ISE 1320P**

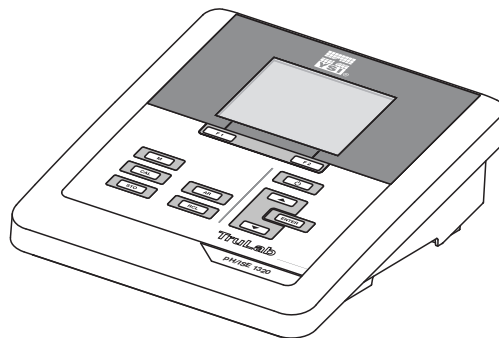

**pH/ISE 1320**

# TruLab pH/ISE 1320(P)

PH/ISE METER



a xylem brand



For the most recent version of the manual, please visit [www.yisi.com](http://www.yisi.com).

**Contact**

YSI  
1725 Brannum Lane  
Yellow Springs, OH 45387 USA  
Tel: +1 937-767-7241  
800-765-4974  
Email: [environmental@ysi.com](mailto:environmental@ysi.com)  
Internet: [www.yisi.com](http://www.yisi.com)

**Copyright**

© 2015 Xylem Inc.

## TruLab pH/ISE 1320 - Contents

<b>1</b>	<b>Overview</b>	<b>7</b>
1.1	TruLab pH/ISE 1320 meter	7
1.2	TruLab pH/ISE 1320P meter	8
1.3	Sensors	8
<b>2</b>	<b>Safety</b>	<b>9</b>
2.1	Safety information	9
2.1.1	Safety information in the operating manual	9
2.1.2	Safety signs on the meter	9
2.1.3	Further documents providing safety information	9
2.2	Safe operation	10
2.2.1	Authorized use	10
2.2.2	Requirements for safe operation	10
2.2.3	Unauthorized use	10
<b>3</b>	<b>Commissioning</b>	<b>11</b>
3.1	Scope of delivery	11
3.2	Power supply	11
3.3	Initial commissioning	11
3.3.1	Inserting the batteries	12
3.3.2	Connecting the power pack	13
3.3.3	Mounting the stand	13
<b>4</b>	<b>Printer (only TruLab pH/ISE 1320 P)</b>	<b>14</b>
4.1	Commissioning / switching the printer on or off	14
4.2	Operation / printing	15
4.3	Printer settings	15
4.4	Maintenance	15
4.4.1	Changing the roll of paper (thermal paper)	15
4.5	What to do if... / printer	16
<b>5</b>	<b>Operation</b>	<b>17</b>
5.1	General operating principles	17
5.1.1	Keypad	17
5.1.2	Display	18
5.1.3	Status information (meter)	18
5.1.4	Socket field	19
5.2	Switching on the meter	19
5.3	Switching off	20
5.4	Navigation	20
5.4.1	Operating modes	20
5.4.2	Measured value display	21
5.4.3	Menus and dialogs	21

---

5.4.4	Elements in menus and dialogs	21
5.4.5	Example 1 on navigation: Setting the language	23
5.4.6	Example 2 on navigation: Setting the date and time	25
5.5	Channel display	27
5.5.1	Display of several sensors in the measuring mode	27
<b>6</b>	<b>pH value</b>	<b>28</b>
6.1	Measuring	28
6.1.1	Measuring the pH value	28
6.1.2	Measuring the temperature	30
6.2	Calibration	31
6.2.1	Why calibrate?	31
6.2.2	When do you have to calibrate?	31
6.2.3	Automatic calibration (AutoCal)	31
6.2.4	Manual calibration (ConCal)	34
6.2.5	Calibration points	37
6.2.6	Calibration data	38
6.2.7	Continuous measurement control (CMC function)	40
<b>7</b>	<b>ORP voltage</b>	<b>41</b>
7.1	Measuring	41
7.1.1	Measuring the ORP	41
7.1.2	Measuring the relative ORP	43
7.1.3	Measuring the temperature	44
7.2	ORP calibration	44
<b>8</b>	<b>Ion concentration</b>	<b>45</b>
8.1	Measuring	45
8.1.1	Measuring the ion concentration	45
8.1.2	Measuring the temperature	47
8.2	Calibration	48
8.2.1	Why calibrate?	48
8.2.2	When to calibrate?	48
8.2.3	Calibration (ISE Cal)	48
8.2.4	Calibration standards	51
8.2.5	Calibration data	51
8.3	Selecting the measuring method	54
8.3.1	<i>Standard addition</i>	55
8.3.2	<i>Standard subtraction</i>	57
8.3.3	<i>Sample addition</i>	60
8.3.4	<i>Sample subtraction</i>	62
8.3.5	Standard addition with blank value correction ( <i>Blank value addition</i> )	64
<b>9</b>	<b>Settings</b>	<b>67</b>
9.1	Measurement settings	67
9.1.1	Settings for pH measurements	67
9.1.2	Buffer sets for calibration	69
9.1.3	Calibration interval	72
9.1.4	Settings for ORP measurements	73
9.2	Settings for ISE measurements	74

---

9.3	Sensor-independent settings . . . . .	76
9.3.1	System . . . . .	76
9.3.2	Data storage . . . . .	77
9.4	Reset . . . . .	77
9.4.1	Resetting the measurement settings . . . . .	77
9.4.2	Resetting the system settings . . . . .	78
<b>10</b>	<b>Data storage . . . . .</b>	<b>79</b>
10.1	Manual data storage . . . . .	79
10.2	Automatic data storage at intervals . . . . .	80
10.3	Measurement data storage . . . . .	82
10.3.1	Editing the measurement data storage . . . . .	82
10.3.2	Erasing the measurement data storage . . . . .	84
10.3.3	Measurement dataset . . . . .	84
10.3.4	Storage locations . . . . .	84
<b>11</b>	<b>Transmitting data (USB interface) . . . . .</b>	<b>85</b>
11.1	Options for data transmission . . . . .	85
11.2	Connecting a PC . . . . .	86
11.3	MultiLab Importer . . . . .	86
<b>12</b>	<b>Maintenance, cleaning, disposal . . . . .</b>	<b>87</b>
12.1	Maintenance . . . . .	87
12.1.1	General maintenance activities . . . . .	87
12.1.2	Replacing the batteries . . . . .	87
12.2	Cleaning . . . . .	88
12.3	Packing . . . . .	88
12.4	Disposal . . . . .	88
<b>13</b>	<b>What to do if . . . . .</b>	<b>89</b>
13.1	pH/ORP . . . . .	89
13.2	ISE . . . . .	91
13.3	General information . . . . .	93
<b>14</b>	<b>Technical data . . . . .</b>	<b>94</b>
14.1	Measuring ranges, resolution, accuracy . . . . .	94
14.1.1	pH/ORP . . . . .	94
14.1.2	ISE . . . . .	95
14.2	General data . . . . .	96
<b>15</b>	<b>Firmware update . . . . .</b>	<b>98</b>
<b>16</b>	<b>Glossary . . . . .</b>	<b>99</b>
<b>17</b>	<b>Index . . . . .</b>	<b>101</b>
<b>18</b>	<b>Contact Information . . . . .</b>	<b>103</b>
18.1	Ordering & Technical Support . . . . .	103
18.2	Service Information . . . . .	103



# 1 Overview

## 1.1 TruLab pH/ISE 1320 meter

The compact precision pH meter TruLab pH/ISE 1320 enables you to carry out pH measurements, ORP measurements and ion selective measurements quickly and reliably.

The TruLab pH/ISE 1320 provides the maximum degree of operating comfort, reliability and measuring certainty for all applications.

The USB interface can be used for data transmission to a PC and for software updates of the meter.

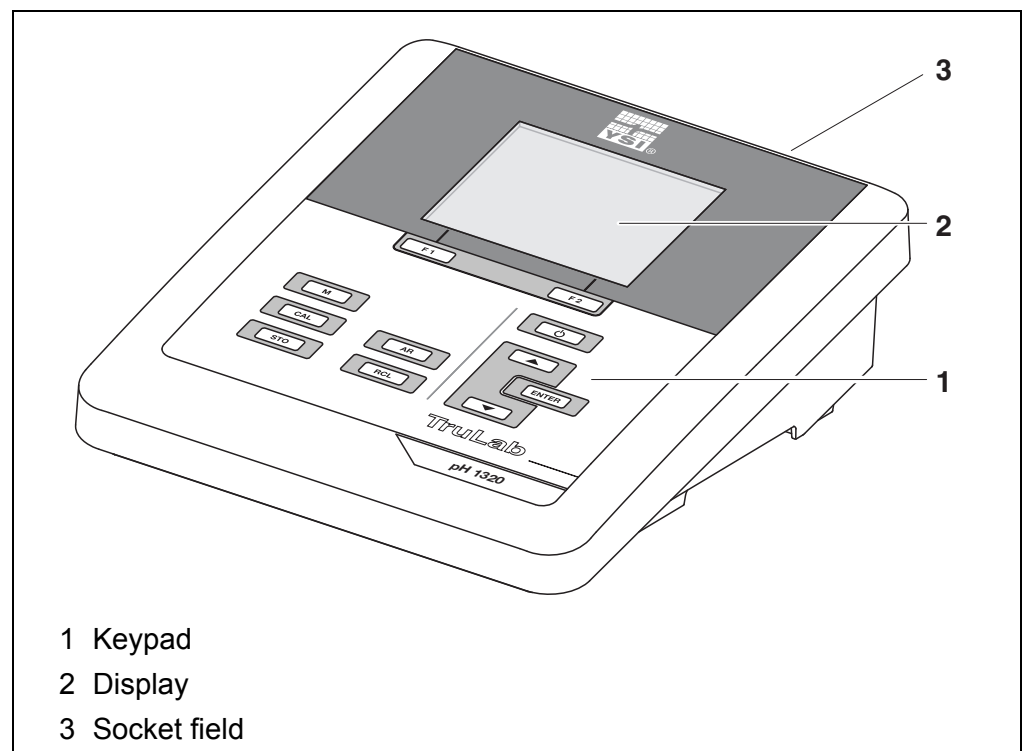

## 1.2 TruLab pH/ISE 1320P meter

The integrated printer of the TruLab pH/ISE 1320 P enables to document measurements according to GLP requirements.



The information concerning the printer of the TruLab pH/ISE 1320 P is given in a separate chapter (see section 4 PRINTER (ONLY TRULAB PH/ISE 1320 P), page 14).

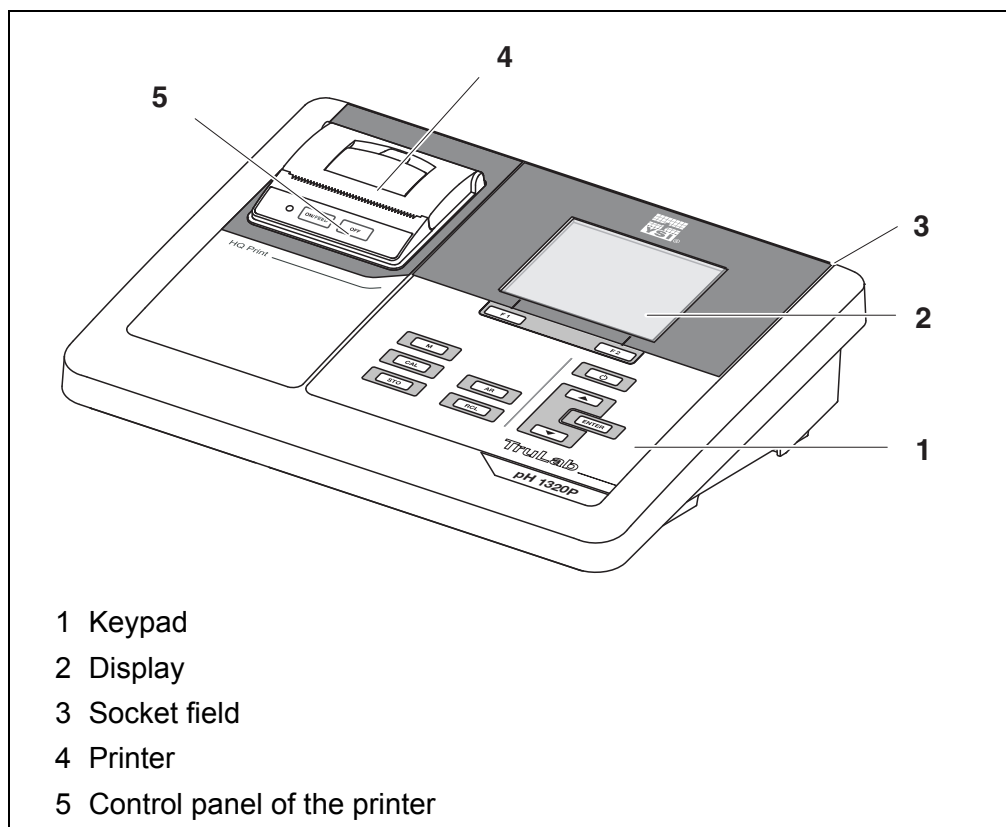

## 1.3 Sensors

A measuring system ready to measure consists of the TruLab pH/ISE 1320 meter and a suitable sensor.

Suitable sensors are pH electrodes, ORP electrodes and ion selective electrodes (ISE).



## 2 Safety

### 2.1 Safety information

#### 2.1.1 Safety information in the operating manual

This operating manual provides important information on the safe operation of the meter. Read this operating manual thoroughly and make yourself familiar with the meter before putting it into operation or working with it. The operating manual must be kept in the vicinity of the meter so you can always find the information you need.

Important safety instructions are highlighted in this operating manual. They are indicated by the warning symbol (triangle) in the left column. The signal word (e.g. "Caution") indicates the level of danger:



#### **WARNING**

indicates a possibly dangerous situation that can lead to serious (irreversible) injury or death if the safety instruction is not followed.



#### **CAUTION**

indicates a possibly dangerous situation that can lead to slight (reversible) injury if the safety instruction is not followed.

#### **NOTE**

indicates a possibly dangerous situation where goods might be damaged if the actions mentioned are not taken.

#### 2.1.2 Safety signs on the meter

Note all labels, information signs and safety symbols on the meter and in the battery compartment. A warning symbol (triangle) without text refers to safety information in this operating manual.

#### 2.1.3 Further documents providing safety information

The following documents provide additional information, which you should observe for your safety when working with the measuring system:

- Operating manuals of sensors and other accessories
- Safety datasheets of calibration or maintenance accessories (such as buffer solutions, electrolyte solutions, etc.)

## **2.2 Safe operation**

### **2.2.1 Authorized use**

This meter is authorized exclusively for pH, ORP and ISE concentrations measurements in the laboratory.

Only the operation and running of the meter according to the instructions and technical specifications given in this operating manual is authorized (see section 14 TECHNICAL DATA, page 94).

Any other use is considered unauthorized.

### **2.2.2 Requirements for safe operation**

Note the following points for safe operation:

- The meter may only be operated according to the authorized use specified above.
- The meter may only be supplied with power by the energy sources mentioned in this operating manual.
- The meter may only be operated under the environmental conditions mentioned in this operating manual.
- The meter may only be opened if this is explicitly described in this operating manual (example: Inserting the batteries).

### **2.2.3 Unauthorized use**

The meter must not be put into operation if:

- it is visibly damaged (e.g. after being transported)
- it was stored under adverse conditions for a lengthy period of time (storing conditions, see section 14 TECHNICAL DATA, page 94).

## 3 Commissioning

### 3.1 Scope of delivery

- pH meter TruLab pH/ISE 1320
- 4 batteries 1.5 V Mignon type AA
- Power pack
- USB cable (A plug on mini B plug)
- Stand
- Stand holder
- Comprehensive operating manual
- Short instructions
- CD-ROM with
  - USB drivers
  - detailed operating manual
  - Software MultiLab Importer

### 3.2 Power supply

The TruLab pH/ISE 1320 is supplied with power in the following ways:

- Mains operation with the supplied power pack
- Battery operation (4 x alkaline manganese batteries, type AA)
- USB operation via a connected USB-B cable

### 3.3 Initial commissioning

Perform the following activities:

- Insert the supplied batteries
- For mains operation: Connect the power pack
- If necessary, mount a stand
- Switch on the meter  
(see section 5.2 SWITCHING ON THE METER, page 19)
- Set the date and time  
(see section 5.4.6 EXAMPLE 2 ON NAVIGATION: SETTING THE DATE AND TIME, page 25)

### 3.3.1 Inserting the batteries



You can operate the meter either with normal batteries or with rechargeable batteries (Ni-MH). In order to charge the batteries, an external charging device is required.

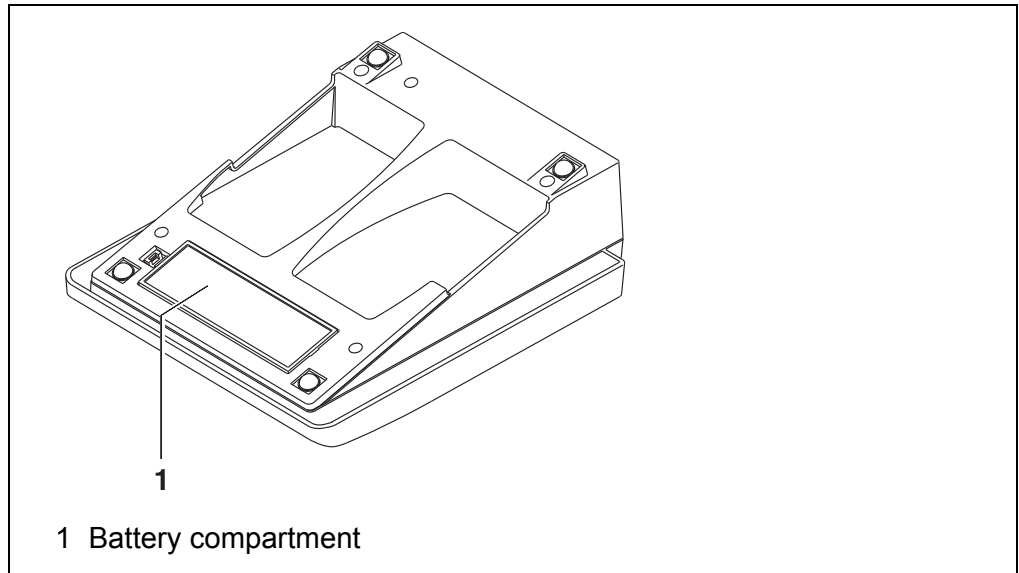

1. Open the battery compartment (1) on the underside of the meter.

**CAUTION**

Make sure that the poles of the batteries are positioned correctly.

The  $\pm$  signs on the batteries must correspond to the  $\pm$  signs in the battery compartment.

2. Place four batteries (type Mignon AA) in the battery compartment.
3. Close the battery compartment (1).
4. Set the date and time  
(see section 5.4.6 EXAMPLE 2 ON NAVIGATION: SETTING THE DATE AND TIME, page 25).

### 3.3.2 Connecting the power pack

**CAUTION**

The line voltage at the operating site must lie within the input voltage range of the original power pack (see section 14 TECHNICAL DATA, page 94).

**CAUTION**

Use original power packs only (see section 14 TECHNICAL DATA, page 94).

1. Connect the plug of the power pack to the socket for the power pack on the TruLab pH/ISE 1320.
2. Connect the original power pack to an easily accessible power outlet.

### 3.3.3 Mounting the stand

The stand base can be mounted at the right side of the meter.

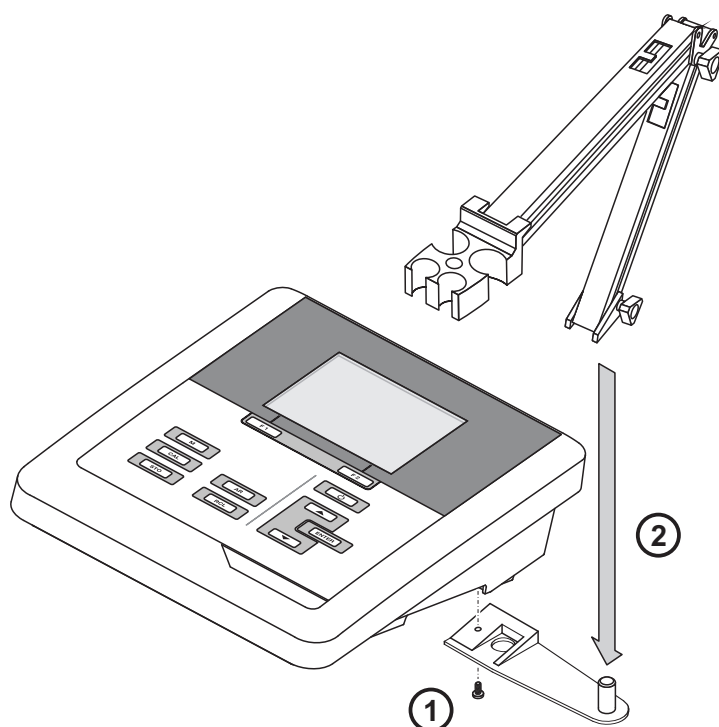

## 4 Printer (only TruLab pH/ISE 1320 P)

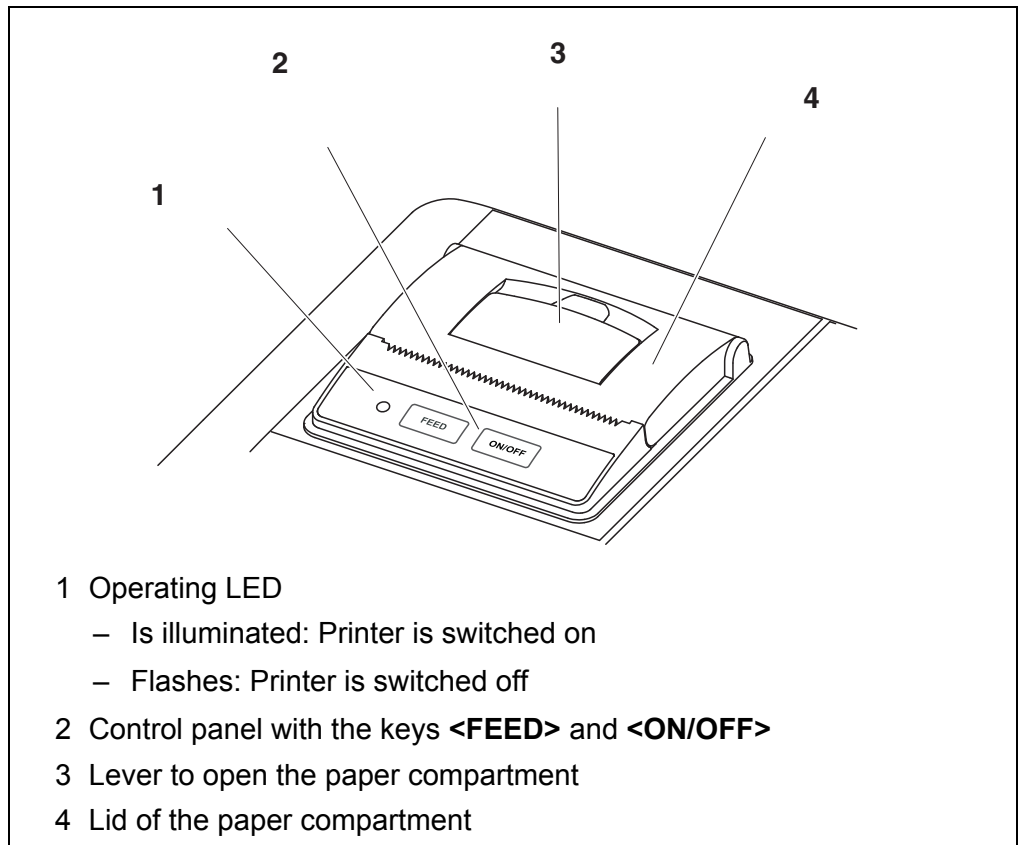

### 4.1 Commissioning / switching the printer on or off

#### Switching on the printer

1. Connect the power pack to the TruLab pH/ISE 1320 P. The LED lights up green. The printer is ready for operation.  
or  
When the printer had been switched off (LED flashing):  
Switch on the printer with **<ON/OFF>**.  
The LED lights up green. The printer is ready for operation.



If there is a USB-B connection at the same time (e.g. to a PC), the data are output to the PC only.

#### Switching off the printer

1. Switch off the printer with **<ON/OFF>**.  
The LED flashes. The printer is switched off.

## 4.2 Operation / printing

Data are only output to the printer if the following requirements are met

- Data are transmitted manually or automatically (see section 11.1 OPTIONS FOR DATA TRANSMISSION, page 85)
- The printer is switched on (LED illuminated)
- There is no USB connection.

## 4.3 Printer settings

To open the *Storage & config* menu, press the **<ENTER\_>** key in the measured value display. After completing the settings, switch to the measured value display with **<M>**.

Default settings are printed in **bold**.

Menu item	Possible setting	Description
<i>System / Printer / Font size</i>	<b>12x20</b> 8x16 7x16	Select the font size for the printer  A print sample (font of the printer) to view the available font sizes can be output with <b>&lt;ON/OFF_&gt;</b> .
<i>System / Printer / Print test page</i>	-	The printer prints the meter information from the menu, <i>System / Service information</i> . The current printer settings are used for the printout.

## 4.4 Maintenance

### 4.4.1 Changing the roll of paper (thermal paper)

1. Pull the lever (3) until the lid (4) of the paper compartment opens.
2. If necessary, remove any remains of the old roll of paper.
3. Insert the new roll of paper. The start of the paper should poke out of the paper compartment.
4. Close the lid (4) of the paper compartment so that it clicks into place.
5. If necessary, move the printer paper forward with **<FEED>**.

#### 4.5 What to do if... / printer

##### Integrated printer does not print

Cause	Remedy
– Printer switched off (LED flashing)	– Switch on the printer (LED illuminated)
– No power pack connected	– Connect the power pack
– USB cable connected	– Disconnect the USB cable from the meter
– Function "store automatically at intervals" with long intervals is switched on	– Switch off the function (see section 10.2 AUTOMATIC DATA STORAGE AT INTERVALS, page 80)
– No paper available	– Insert a roll of paper

##### Printer operating - paper not being printed

Cause	Remedy
– Paper inserted the wrong way up	– Turn the roll of paper around and insert it with the other side upwards

##### Integrated printer prints automatically

Cause	Remedy
– The function "store automatically at intervals" or "transmit data automatically at intervals" is switched on	– Switch off the functions (see section 10.2 AUTOMATIC DATA STORAGE AT INTERVALS, page 80 or section 11.1 OPTIONS FOR DATA TRANSMISSION, page 85)











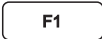

## 5 Operation

### 5.1 General operating principles

#### 5.1.1 Keypad

In this operating manual, keys are indicated by brackets <.> .

The key symbol (e.g. <ENTER>) generally indicates a short keystroke (under 2 sec) in this operating manual. A long keystroke (approx. 2 sec) is indicated by the underscore behind the key symbol (e.g. <ENTER\_\_>).

	<F1>: <F1__>:	Softkeys providing situation dependent functions, e.g.: <F2>/[USB output]: Outputs data to the USB interface <F2__>/[USB output]: Configures the automatic data output to the USB interface
	<F2>: <F2__>:	
	<On/Off>:	Switches the meter on or off
	<M>:	Selects the measured parameter / Quits the settings
	<CAL>: <CAL__>:	Calls up the calibration procedure Displays the calibration data
	<STO>: <STO__>:	Saves a measured value manually Opens the menu for the automatic save function
	<RCL>: <RCL__>:	Displays the manually stored measured values Displays the automatically stored measured values
 	<▲><▼>: <▲__><▼__>:	Menu control, navigation Increments, decrements values Increments, decrements values continuously
	<ENTER>: <ENTER__>:	Opens the menu for measurement settings / confirms entries Opens the menu for system settings
	<AR>	Freezes the measured value (HOLD function) Switches the AutoRead measurement on or off

### 5.1.2 Display

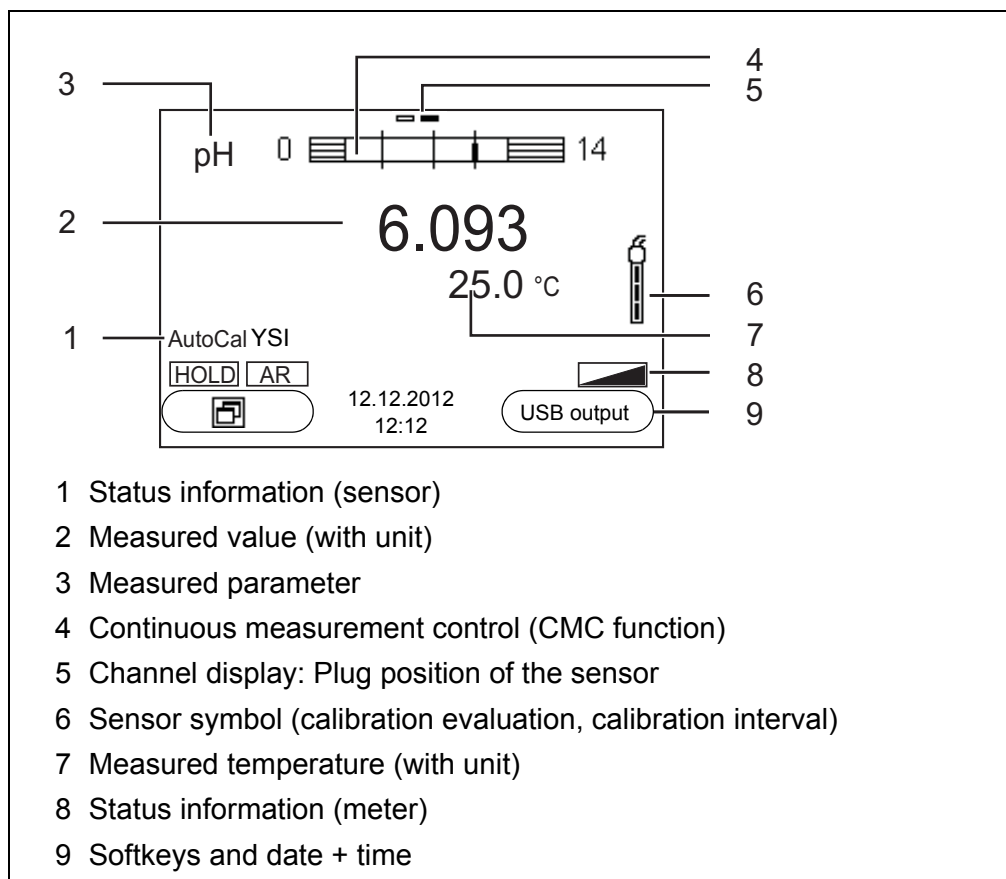

### 5.1.3 Status information (meter)

AR	Stability control (AutoRead) is active
HOLD	Measured value is frozen (<AR> key)
	Batteries are almost empty

### 5.1.4 Socket field

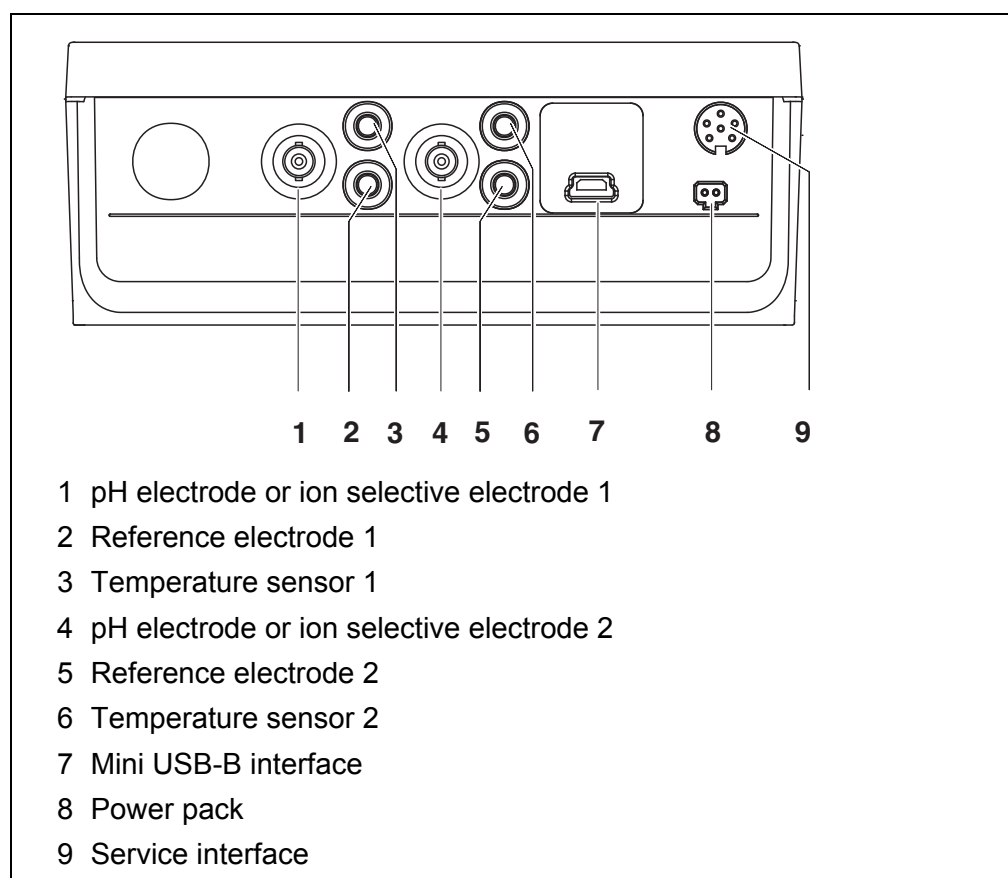

#### CAUTION

Only connect sensors to the meter that cannot return any voltages or currents that are not allowed (> SELV and > current circuit with current limiting).

Almost all customary sensors fulfill these conditions.

### 5.2 Switching on the meter

1. Switch the meter on with **<On/Off>**.  
The meter performs a self-test.  
The display shows the manufacturer's logo while the self-test is being performed.  
The measured value display appears.

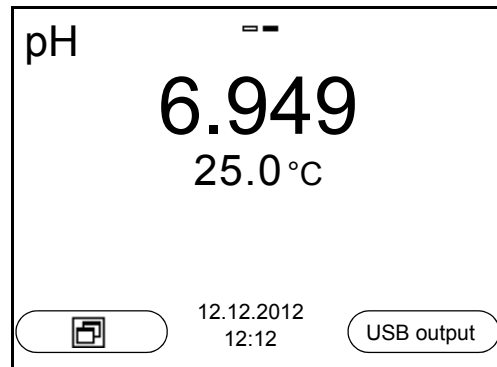

### 5.3 Switching off

1. Switch the meter off with **<On/Off>**.

**Automatic switch-off** The instrument has an automatic switch-off function in order to save the batteries (see section 9.3.1 SYSTEM, page 76). The automatic switchoff switches off the measuring instrument if no key is pressed for an adjustable period.

The automatic switchoff is not active

- if the communication cable is connected
- if the *Automatic data storage* function is active, or with *automatic data transmission*
- if the power pack is connected

**Display illumination** The meter automatically switches off the display illumination if no key is pressed for 30 seconds. The illumination is switched on with the next keystroke again.

You can also generally switch the display illumination on or off (see section 9.3.1 SYSTEM, page 76).

### 5.4 Navigation

The principles of navigation in menus and dialogs are explained in the following sections.

#### 5.4.1 Operating modes

The meter has the following operating modes:

Operating mode	Description
<b>Measuring</b>	The measurement data of the connected sensor are shown in the measured value display
<b>Calibration</b>	The course of a calibration with calibration information, functions and settings is displayed
<b>Storage in memory</b>	The meter stores measuring data automatically or manually
<b>Transmitting data</b>	The meter transmits measuring data and calibration records to a USB-B interface automatically or manually
<b>Setting</b>	The system menu or a sensor menu with submenus, settings and functions is displayed

Only those displays and functions are available in the active operating mode that are currently being required.

#### 5.4.2 Measured value display

In the measured value display, open the setting menus with **<MENU/ENTER>**. The current functions of the softkeys are shown on the display.

- Use **<MENU/ENTER>** (short pressure) to open the menu for calibration and measurement settings for the displayed measured parameter.
- Use **<MENU/ENTER\_\_>** (long keystroke (approx. 2 s) to open the *Storage & config* menu with the sensor-independent settings.

Use the keys of the keypad to carry out further functions such as storage or calibration (see section 5.1.1 KEYPAD, page 17). These functions are not available in other operating situations.

#### 5.4.3 Menus and dialogs

The menus for settings and dialogs in procedures contain further submenus.

- To select a subelement, use the **<▲><▼>** keys. The current selection is displayed with a frame.
- To make further settings, switch to the next higher menu level with **<F1>**[Back].
- Use **<M>** to return to the measured value display.

#### 5.4.4 Elements in menus and dialogs

- Submenus  
The name of the submenu is displayed at the upper edge of the frame. Submenus are opened by confirming with **<MENU/ENTER>**. Example:

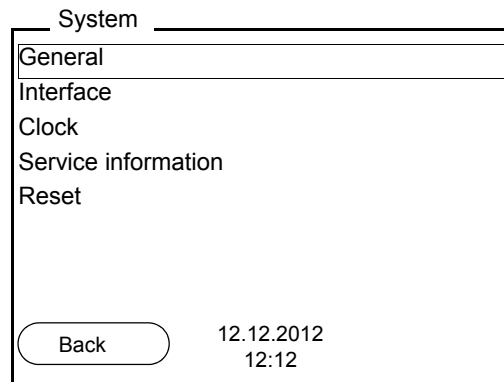

● **Settings**

Settings are indicated by a colon. The current setting is displayed on the right-hand side. The setting mode is opened with <MENU/ENTER>. Subsequently, the setting can be changed with <▲><▼> and <MENU/ENTER>. Example:

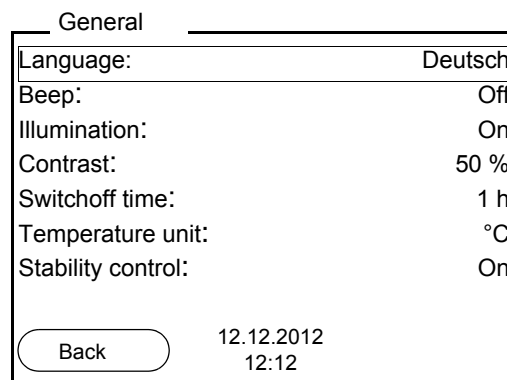

● **Functions**

Functions are designated by the name of the function. They are immediately carried out by confirming with <MENU/ENTER>. Example: Display the *Calibration record* function.

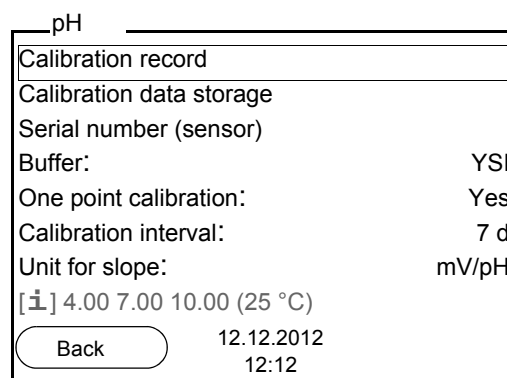

● **Messages**

Information is marked by the **i** symbol. They cannot be selected. Example:

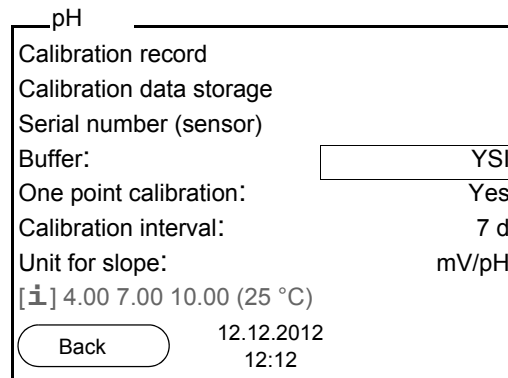

#### 5.4.5 Example 1 on navigation: Setting the language

1. Press the **<On/Off>** key.  
The measured value display appears.  
The instrument is in the measuring mode.

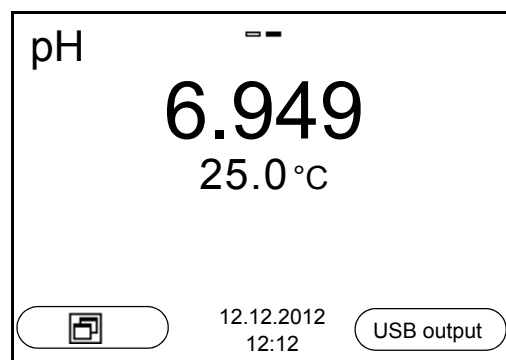

2. Using **<MENU/ENTER\_>**, open the *Storage & config* menu.  
The instrument is in the setting mode.

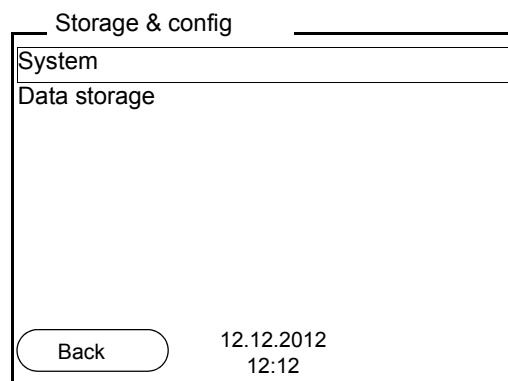

3. Select the *System* submenu with **<▲><▼>**.  
The current selection is displayed with a frame.
4. Open the *System* submenu with **<MENU/ENTER>**.

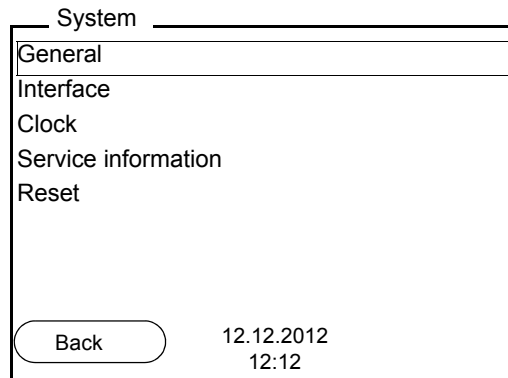

5. Select the *General* submenu with <▲><▼>. The current selection is displayed with a frame.
6. Open the *General* submenu with <MENU/ENTER>.

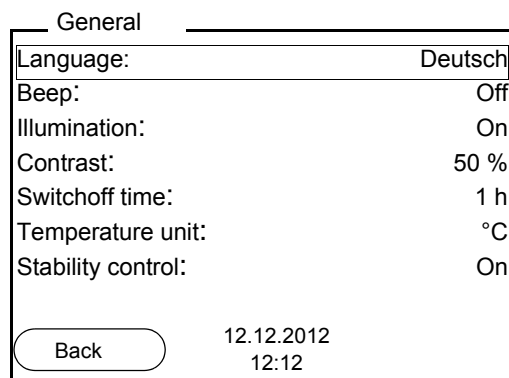

7. Open the setting mode for the *Language* with <MENU/ENTER>.

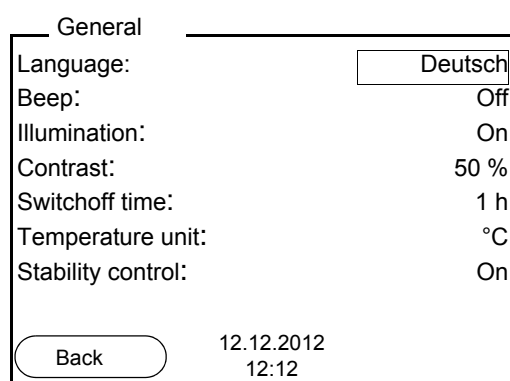

8. Select the required language with <▲><▼>.
9. Confirm the setting with <MENU/ENTER>. The meter switches to the measuring mode. The selected language is active.



### 5.4.6 Example 2 on navigation: Setting the date and time

The measuring instrument has a clock with a date function. The date and time are shown in the measured value display.

When storing measured values and calibrating, the current date and time are automatically stored as well.

The correct setting of the date and time and date format is important for the following functions and displays:

- Current date and time
- Calibration date
- Identification of stored measured values.

Therefore, check the time at regular intervals.



After a fall of the supply voltage (empty batteries), the date and time are reset.

The date format can be switched from the display of day, month, year (*dd.mm.yyyy*) to the display of month, day, year (*mm/dd/yyyy* or *mm.dd.yyyy*).

1. In the measured value display:  
Using **<MENU/ENTER>**, open the *Storage & config* menu.  
The instrument is in the setting mode.
2. Select and confirm the *System / Clock* menu with **<▲><▼>** and **<MENU/ENTER>**.  
The setting menu for the date and time opens up.
3. Select and confirm the *Time* menu with **<▲><▼>** and **<MENU/ENTER>**.  
The hours are highlighted.

Clock	
Date format:	dd.mm.yyyy
Date:	12.12.2012
Time:	12:12:25
<div style="display: flex; justify-content: space-between; align-items: center;"> <span>Back</span> <span>12.12.2012 12:12</span> </div>	

4. Change and confirm the setting with **<▲><▼>** and **<MENU/ENTER>**.  
The minutes are highlighted.
5. Change and confirm the setting with **<▲><▼>** and **<MENU/ENTER>**.  
The seconds are highlighted.
6. Change and confirm the setting with **<▲><▼>** and **<MENU/ENTER>**.  
The time is set.

7. If necessary, set the *Date* and *Date format*. The setting is made similarly to that of the time.
8. To make further settings, switch to the next higher menu level with [Back]<F1>.  
or  
Switch to the measured value display with <M>.  
The instrument is in the measuring mode.

## 5.5 Channel display

The TruLab pH/ISE 1320 manages the connected sensors and displays which sensor is plugged to which connection.

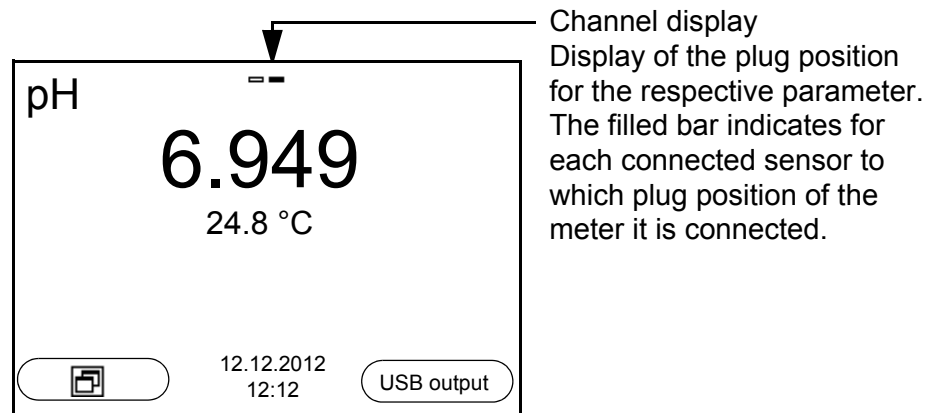

### 5.5.1 Display of several sensors in the measuring mode

The measured values of the connected sensors can be displayed in the following ways:

- Clear display of all connected sensors
- Detailed display of one sensor (e.g. incl. CMC feature with pH sensors)

With the softkey you can very easily switch between the two display types. The suitable softkey is displayed depending on the operating situation.

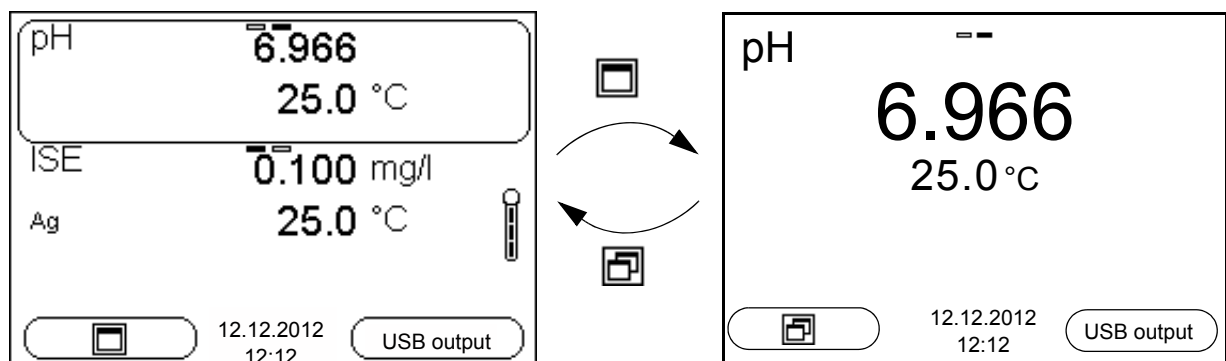

## 6 pH value

### 6.1 Measuring

#### 6.1.1 Measuring the pH value

##### NOTE

When connecting an earthed PC/printer, measurements cannot be performed in earthed media as the values would be incorrect. The USB interface is not galvanically isolated.



To ensure the high measurement accuracy of the measuring system, always measure with a calibrated electrode (see section 6.2 CALIBRATION, page 31).

1. Connect the pH electrode to the meter.
2. If necessary, select the measured parameter with <M>.
3. When measuring without temperature sensor:  
Temper the test sample or measure the current temperature and enter it with <▲> <▼>.
4. Immerse the pH electrode in the test sample.  
The measured value is checked for stability (automatic stability control).  
The display of the measured parameter flashes.
5. Wait for a stable measured value.  
The display of the measured parameter no longer flashes.

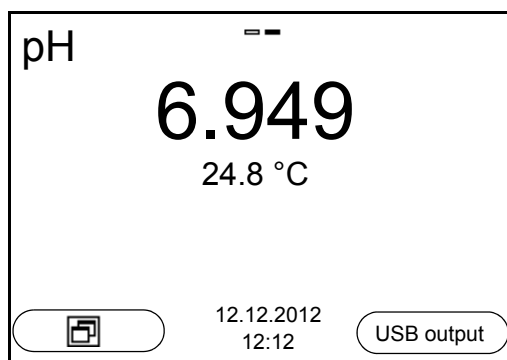

#### Stability control (AutoRead) & HOLD function

The stability control function (*AutoRead*) continually checks the stability of the measurement signal. The stability has a considerable impact on the reproducibility of measured values.

The measured parameter flashes on the display

- as soon as the measured value is outside the stability range
- when the automatic *Stability control* is switched off.

You can activate or switch off the automatic *Stability control* function (see section 9.3.1 SYSTEM, page 76).

- Freeze the measured value with **<AR>**.  
The [HOLD] status indicator is displayed.  
The HOLD function is active.



You can terminate the *Stability control* function and the HOLD function with **<AR>** or **<M>** at any time.

- Using **<ENTER>**, activate the *Stability control* function manually. The [AR] status indicator appears while the measured value is assessed as not stable. A progress bar is displayed and the display of the measured parameter flashes. The [HOLD][AR] status indicator appears as soon as a stable measured value is recognized. The progress bar disappears and the display of the measured parameter stops flashing. The current measurement data is output to the interface. Measurement data meeting the stability control criterion is marked by AR.



You can prematurely terminate the *Stability control* function manually with **<ENTER>** at any time. If the *Stability control* function is prematurely terminated, the current measurement data are output to the interface without the AutoRead info.

- Using **<ENTER>**, start a further measurement with stability control.  
or  
Release the frozen measured value again with **<AR>** or **<M>**.  
The [AR] status display disappears. The display switches back to the previous indication.

#### Criteria for a stable measured value

The *Stability control* function checks whether the measured values are stable within the monitored time interval.

Measured parameter	Time interval	Stability in the time interval
pH value	15 seconds	$\Delta$ : better than 0.01 pH
Temperature	15 seconds	$\Delta$ : better than 0.5 °C

The minimum duration until a measured value is assessed as stable is the monitored time interval. The actual duration is mostly longer.

### 6.1.2 Measuring the temperature

For reproducible pH measurements, it is essential to measure the temperature of the test sample.

You have the following options to measure the temperature:

- Automatic measurement of the temperature with the temperature sensor (NTC30 or Pt1000) integrated in the sensor.
- Measurement by an external temperature sensor.
- Manual determination and input of the temperature.

The measuring instrument recognizes whether a suitable sensor is connected and automatically switches on the temperature measurement.

The display of the temperature indicates the active temperature measuring mode:

Temperature sensor	Resolution of the temp. display	Temp. measurement
yes	0.1 °C	Automatic with temperature sensor
-	1 °C	Manual

If you wish to measure (or calibrate) without temperature sensor, proceed as follows:

1. Measure the current temperature of the test sample.
2. In the **<MENU/ENTER>/pH/Man. temperature** menu, set the temperature value with **<▲><▼>**.

## 6.2 Calibration

### 6.2.1 Why calibrate?

pH electrodes age. This changes the zero point (asymmetry) and slope of the pH electrode. As a result, an inexact measured value is displayed. Calibration determines and stores the current values of the zero point and slope of the electrode.

Thus, you should calibrate at regular intervals.

### 6.2.2 When do you have to calibrate?

- After connecting a sensor
- Routinely within the framework of the company quality assurance
- When the calibration interval has expired

### 6.2.3 Automatic calibration (AutoCal)

Make sure that in the sensor menu, *Buffer* menu, the buffer set is correctly selected (see 9.1.1 SETTINGS FOR PH MEASUREMENTS, PAGE 67).

Use any one to five buffer solutions of the selected buffer set in ascending or descending order.

Below, calibration with Technical buffers (TEC) is described. When other buffer sets are used, other nominal buffer values are displayed. Apart from that, the procedure is identical.



If single-point calibration was set in the menu, the calibration procedure is automatically finished with the measurement of buffer solution 1 and the calibration record is displayed.

1. Connect the pH electrode to the meter.
2. Keep the buffer solutions ready.  
When measuring without temperature sensor:  
Temper the buffer solutions or measure the current temperature.
3. In the measured value display, select the measured parameter pH or mV with **<M>**.
4. Start the calibration with **<CAL>**.  
The calibration display for the first buffer appears (voltage display).

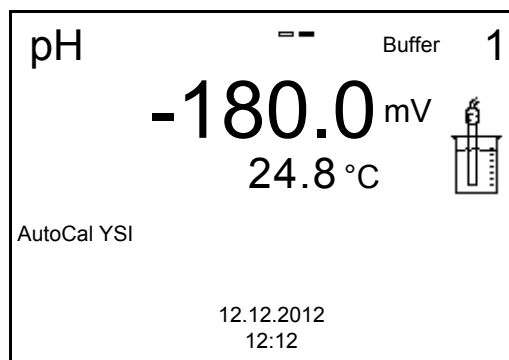

5. Thoroughly rinse the electrode with deionized water.
6. Immerse the electrode in the first buffer solution.
7. When measuring without temperature sensor:  
Enter the temperature of the buffer with <▲><▼>.
8. Start the measurement with <ENTER>.  
The measured value is checked for stability (stability control). The [AR] status indicator is displayed. A progress bar is displayed and the display of the measured parameter flashes.

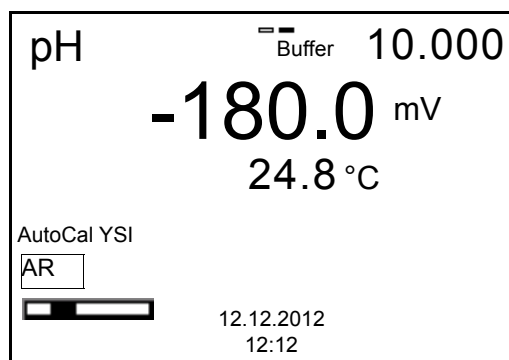

9. Wait for the end of the measurement with stability control or accept the calibration value with <ENTER>.  
The calibration display for the next buffer appears (voltage display).
10. If necessary, finish the calibration procedure as a single-point calibration with <M>.  
The calibration record is displayed.



For **single-point calibration**, the instrument uses the Nernst slope (-59.2 mV/pH at 25 °C) and determines the zero point of the electrode.

### Continuing with two-point calibration

11. Thoroughly rinse the electrode with deionized water.
12. Immerse the electrode in the second buffer solution.
13. When measuring without temperature sensor:  
Enter the temperature of the buffer with <▲><▼>.



14. Start the measurement with **<ENTER>**.  
The measured value is checked for stability (stability control). The [AR] status indicator is displayed. A progress bar is displayed and the display of the measured parameter flashes.

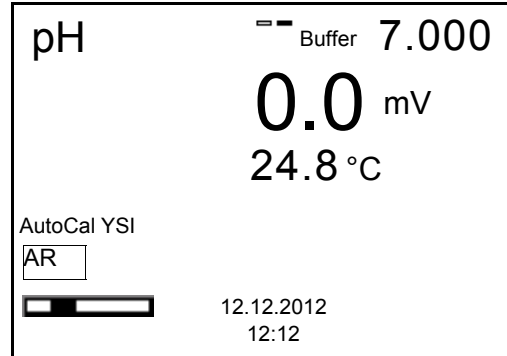

15. Wait for the measurement with stability control to be completed or terminate the stability control and take over the calibration value with **<ENTER>**.  
The calibration display for the next buffer appears (voltage display).
16. If necessary, finish the calibration procedure as a two-point calibration with **<M>**.  
The calibration record is displayed.

### Continuing with three- to five-point calibration

17. Thoroughly rinse the electrode with deionized water.
18. Immerse the electrode in the next buffer solution.
19. When measuring without temperature sensor:  
Enter the temperature of the buffer with **<▲><▼>**.
20. Start the measurement with **<ENTER>**.  
The measured value is checked for stability (stability control). The [AR] status indicator is displayed. A progress bar is displayed and the display of the measured parameter flashes.

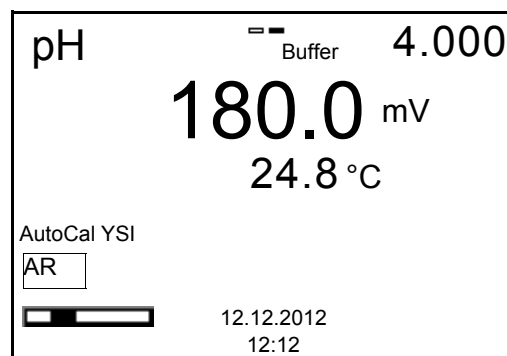

21. Wait for the measurement with stability control to be completed or terminate the stability control and take over the calibration value with **<ENTER>**.



Calibration is automatically completed after the last buffer of a buffer set has been measured. Then the calibration record is displayed.

The calibration line is determined by linear regression.

#### 6.2.4 Manual calibration (ConCal)

Make sure that in the sensor menu, *Buffer* menu, the *ConCal* buffer set is selected (see section 9.1.1 SETTINGS FOR PH MEASUREMENTS, page 67).

Use any one to five buffer solutions in ascending or descending order.



If single-point calibration was set in the menu, the calibration procedure is automatically finished with the measurement of buffer solution 1 and the calibration record is displayed.

1. Connect the pH electrode to the meter.  
The pH measuring window is displayed.
2. Keep the buffer solutions ready.  
When measuring without temperature sensor:  
Temper the buffer solutions or measure the current temperature.
3. In the measured value display, select the measured parameter pH or mV with **<M>**.
4. Start the calibration with **<CAL>**.  
The calibration display appears.

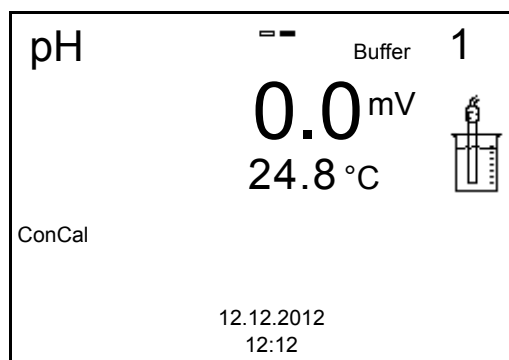

5. Thoroughly rinse the electrode with deionized water.
6. Immerse the electrode in the first buffer solution.
7. When measuring without temperature sensor:  
Enter the temperature of the buffer with **<▲><▼>**.
8. Start the measurement with **<ENTER>**.  
The measured value is checked for stability (stability control). The [AR] status indicator is displayed. A progress bar is displayed and the display of the measured parameter flashes.

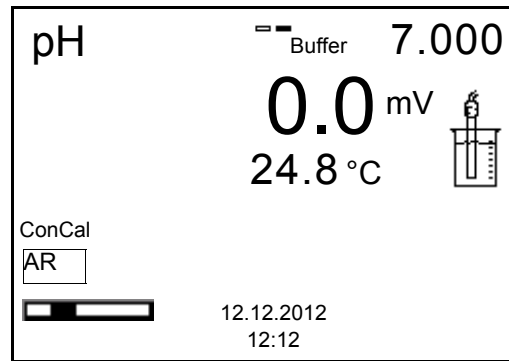

9. Wait for the end of the measurement with stability control or accept the calibration value with **<ENTER>**.  
The calibration display for the setting of the nominal buffer value appears.

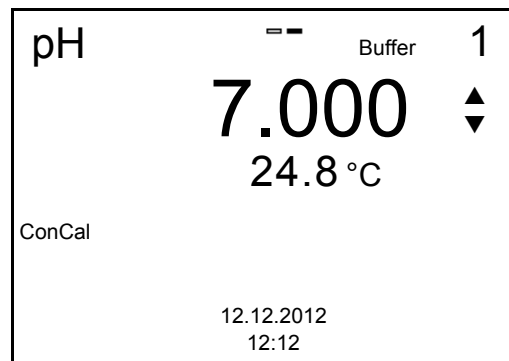

10. Set the nominal buffer value for the measured temperature with **<▲><▼>**.
11. Accept the set calibration value with **<ENTER>**.  
The calibration display for the next buffer appears (voltage display).
12. If necessary, finish the calibration procedure as a single-point calibration with **<M>**.  
The calibration record is displayed.



For **single-point calibration**, the instrument uses the Nernst slope (-59.2 mV/pH at 25 °C) and determines the zero point of the electrode.

### Continuing with two-point calibration

13. Thoroughly rinse the electrode with deionized water.
14. Immerse the electrode in the second buffer solution.
15. When measuring without temperature sensor:  
Enter the temperature of the buffer with **<▲><▼>**.
16. Start the measurement with **<ENTER>**.  
The measured value is checked for stability (stability control). The [AR] status indicator is displayed. A progress bar is displayed and the display of the measured parameter flashes.

17. Wait for the measurement with stability control to be completed or terminate the stability control and take over the calibration value with **<ENTER>**.  
The calibration display for the setting of the nominal buffer value appears.

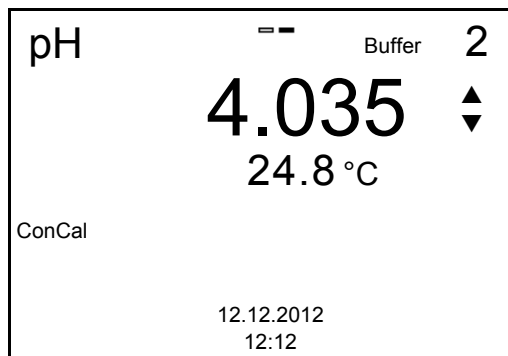

18. Set the nominal buffer value for the measured temperature with **<▲><▼>**.
19. Accept the set calibration value with **<ENTER>**.  
The calibration display for the next buffer appears (voltage display).
20. Finish the calibration procedure as a two-point calibration with **<M>**.  
The calibration record is displayed.

**Continuing with  
three- to five-point  
calibration**

21. Thoroughly rinse the electrode with deionized water.
22. Immerse the electrode in the next buffer solution.
23. When measuring without temperature sensor:  
Enter the temperature of the buffer with **<▲><▼>**.
24. Start the measurement with **<ENTER>**.  
The measured value is checked for stability (stability control). The [AR] status indicator is displayed. A progress bar is displayed and the display of the measured parameter flashes.
25. Wait for the measurement with stability control to be completed or terminate the stability control and take over the calibration value with **<ENTER>**.  
The calibration display for the setting of the nominal buffer value appears.

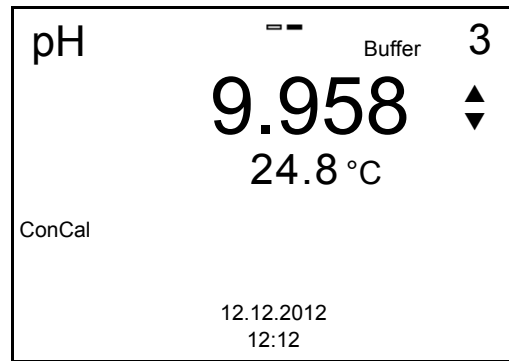

- 26 Set the nominal buffer value for the measured temperature with  $\langle \blacktriangle \rangle \langle \blacktriangledown \rangle$ .
- 27 Accept the set calibration value with  $\langle \text{ENTER} \rangle$ .  
The calibration display for the next buffer appears (voltage display).
- 28 Use  $\langle \text{M} \rangle$  to finish calibration or  
Continue calibrating using the next buffer with  $\langle \text{ENTER} \rangle$ .



After the fifth buffer has been measured the calibration is automatically finished. Then the calibration record is displayed.

The calibration line is determined by linear regression.

### 6.2.5 Calibration points

Calibration can be performed using one to five buffer solutions in any order (single-point to five-point calibration). The meter determines the following values and calculates the calibration line as follows:

	Values to be determined	Displayed calibration data
<b>1-point</b>	<i>Asy</i>	<ul style="list-style-type: none"> <li>● Zero point = <i>Asy</i></li> <li>● Slope = Nernst slope (-59.2 mV/pH at 25 °C)</li> </ul>
<b>2-point</b>	<i>Asy</i> <i>Slp.</i>	<ul style="list-style-type: none"> <li>● Zero point = <i>Asy</i></li> <li>● Slope = <i>Slp.</i></li> </ul>
<b>3-point to 5-point</b>	<i>Asy</i> <i>Slp.</i>	<ul style="list-style-type: none"> <li>● Zero point = <i>Asy</i></li> <li>● Slope = <i>Slp.</i></li> </ul> <p>The calibration line is calculated by linear regression.</p>



You can display the slope in the units, mV/pH or % (see section 9.1.1 SETTINGS FOR PH MEASUREMENTS, page 67).

### 6.2.6 Calibration data



The calibration record is automatically transmitted to the interface after calibrating.

#### Displaying the calibration data

The calibration record of the last calibration is to be found under the menu item, **<MENU/ENTER> / Calibration / / Calibration record**. To open it, press the **<CAL\_\_>** key in the measured value display.

Subsequently, you can transmit the displayed calibration data to the interface, e. g. to a PC, with **<F2>[USB output]**.





#### Displaying the calibration data storage

The calibration records of the last calibrations (up to 10) are given in the menu, **<MENU/ENTER>/Calibration / Calibration data storage**.

Menu item	Setting/function	Description
<i>Calibration / Calibration data storage / Display</i>	-	Displays the calibration record.  Further options: <ul style="list-style-type: none"> <li>● Scroll through the calibration records with <b>&lt;▲&gt;&lt;▼&gt;</b>.</li> <li>● Output the displayed calibration record to the interface with <b>&lt;F2&gt;/[USB output]</b>.</li> <li>● Quit the display with <b>&lt;F1&gt;/[Back]</b> or <b>&lt;MENU/ENTER&gt;</b>.</li> <li>● Switch directly to the measured value display with <b>&lt;M&gt;</b>.</li> </ul>
<i>Calibration / Calibration data storage / Output to USB</i>	-	Outputs the calibration records to the interface.

#### Calibration evaluation

After calibrating, the meter automatically evaluates the calibration. The zero point and slope are evaluated separately. The worse evaluation of both is taken into account. The evaluation appears on the display and in the calibration record.

Display	Calibration record	Zero point [mV]	Slope [mV/pH]
	+++	-15 ... +15	-60.5 ... -58.0
	++	-20 ... <-15 or >+15 ... +20	>-58.0 ... -57.0
	+	-25 ... <-20 or >+20 ... +25	-61.0 ... <-60.5 or >-57.0 ... -56.0
	-	-30 ... <-25 or >+25 ... +30	-62.0 ... <-61.0 or >-56.0 ... -50.0
Clean the electrode according to the electrode operating manual			
<i>Error</i>	<i>Error</i>	-30 ... +30	-62.0 ... -50.0
Error elimination (see section 13 WHAT TO DO IF..., page 89)			

### Calibration record (example)

```

pH/ISE 1320
Ser. no. 11292113

CALIBRATIONpH
12.12.2012 15:55

Ser. no. 10501234
AutoCal TEC
Buffer 1          4.00
Buffer 2          7.00
Buffer 3          10.00
Voltage 1         184,0 mV
Voltage 2         3,0 mV
Voltage 3         -177,0 mV
Temperature 1     24.0 °C
Temperature 2     24.0 °C
Temperature 3     24.0 °C
Slope             -60.2 mV/pH
Asymmetry         4.0 mV
Sensor           +++

```

### 6.2.7 Continuous measurement control (CMC function)

The Continuous Measurement Control (CMC function) facilitates to evaluate the current measured value instantly and definitely.

After each successful calibration the scale of the pH measuring range is displayed in the measured value display. Here you can very clearly see whether or not the current measured value is in the calibrated part of the measuring range.

The following information is displayed:

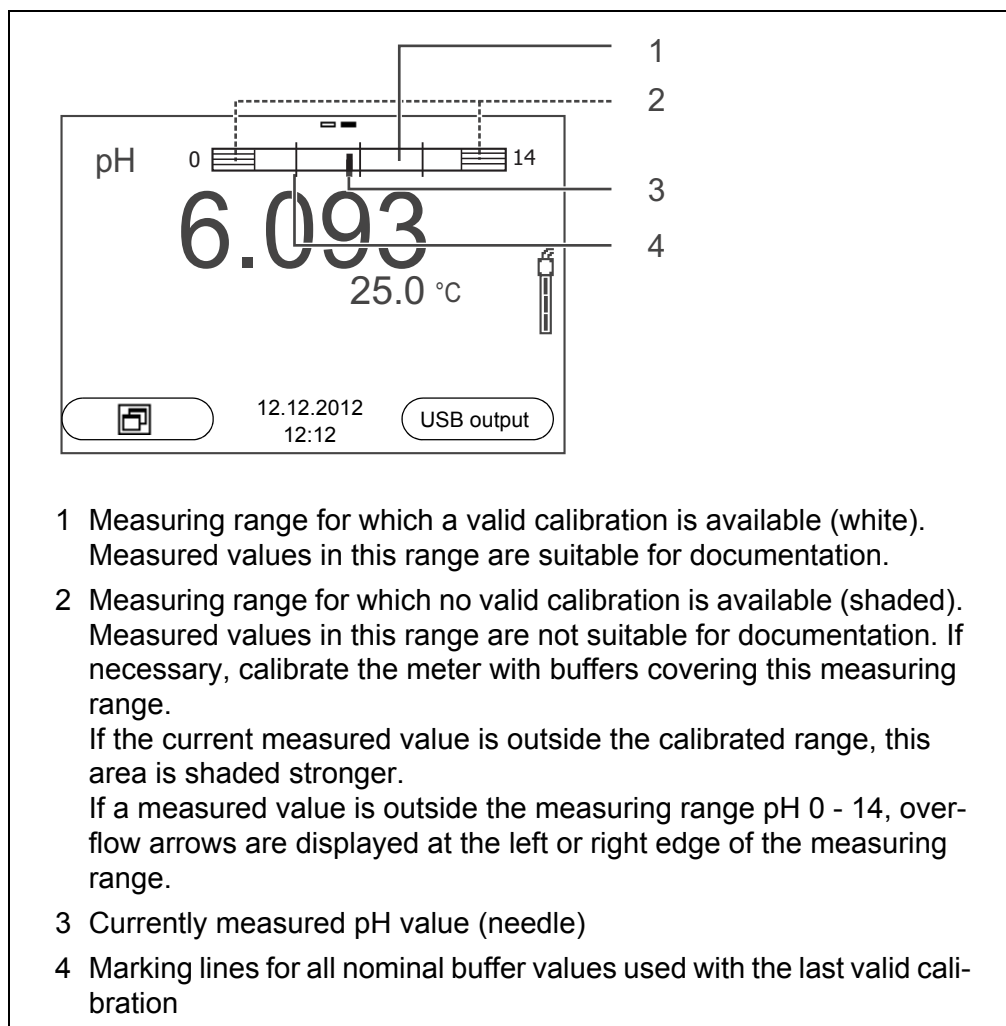

The limits of the calibrated range are determined by the buffers used for calibration:

Lower limit: Buffer with lowest pH value - 2 pH units  
Upper limit: Buffer with highest pH value + 2 pH units



## 7 ORP voltage

### 7.1 Measuring

#### 7.1.1 Measuring the ORP

##### NOTE

When connecting an earthed PC/printer, measurements cannot be performed in earthed media as the values would be incorrect. The USB interface is not galvanically isolated.

1. Connect the ORP electrode to the meter.
2. If necessary, select the U (mV) display with <M>.
3. When measuring without temperature sensor:  
Measure the temperature of the test sample.  
In the <MENU/ENTER>/U/Man. temperature menu, set the temperature value with <▲><▼>.
4. Rinse the ORP electrode and immerse it in the test sample.  
The measured value is checked for stability (automatic stability control).  
The display of the measured parameter flashes.
5. Wait for a stable measured value.  
The display of the measured parameter no longer flashes.

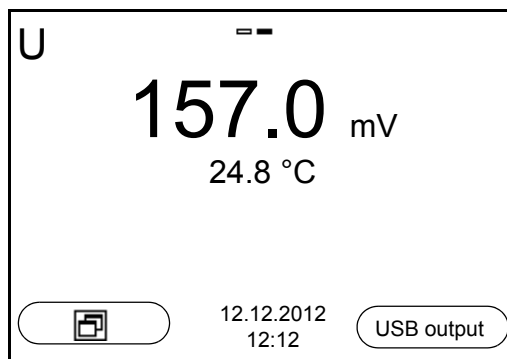

#### Stability control (AutoRead)

The stability control function (*AutoRead*) continually checks the stability of the measurement signal. The stability has a considerable impact on the reproducibility of measured values.

You can activate or switch off the automatic *Stability control* function (see section 9.3.1 SYSTEM, page 76).

The measured parameter flashes on the display

- as soon as the measured value is outside the stability range
- when you switch over between the measured parameters with <M>.
- when the automatic *Stability control* is switched off.

#### Criteria for a stable measured value

The *Stability control* function checks whether the measured values are stable within the monitored time interval.

Measured parameter	Time interval	Stability in the time interval
ORP voltage	15 seconds	$\Delta$ : better than 0.3 mV
Temperature	15 seconds	$\Delta$ : better than 0.5 °C

The minimum duration until a measured value is assessed as stable is the monitored time interval. The actual duration is mostly longer.

### Manually starting the stability control

You can start the *Stability control* manually at any time, irrespective of the setting for automatic *Stability control* (see section 9.3.1 SYSTEM, page 76) in the *System* menu.

1. Freeze the measured value with **<AR>**.  
The [HOLD] status indicator is displayed.
2. Using **<ENTER>**, activate the *Stability control* function manually.  
The [AR] status indicator appears while the measured value is assessed as not stable. A progress bar is displayed and the display of the measured parameter flashes.  
The [HOLD][AR] status indicator appears as soon as a stable measured value is recognized. The progress bar disappears and the display of the measured parameter stops flashing.  
The current measurement data is output to the interface. Measurement data meeting the stability control criterion is marked by AR.



You can prematurely terminate the *Stability control* function manually with **<ENTER>** at any time. If the *Stability control* function is prematurely terminated, the current measurement data are output to the interface without the AutoRead info.

3. Using **<ENTER>**, start a further measurement with *Stability control*.  
or  
Release the frozen measured value again with **<AR>**.  
The display switches to the measured value display.  
The [AR][HOLD] status display disappears.

### Freezing the measured value (HOLD function)

With the HOLD function, you can freeze the current measured value. The displayed measured value stops changing until you switch the HOLD function off.



If the HOLD function is active, you can, e.g. start a manual measurement with stability control.

1. Freeze the measured value with **<AR>**.  
The [HOLD] status indicator is displayed.

2. Release the frozen measured value again with **<AR>**.  
The HOLD function is switched off.  
The [HOLD] status display disappears.

### 7.1.2 Measuring the relative ORP

To measure the difference of the ORPs of two solutions, you have to define the ORP of one solution as the zero point first.



pH and ORP electrodes can be used to determine the relative ORP.

1. Connect the ORP electrode to the meter.
2. Prepare the reference solution for the determination of the reference point.
3. Select the  $\Delta U$  (mV display with **<M>**).
4. Immerse the ORP electrode in the reference solution.
5. Display the potential of the current zero point with **<CAL>**.
6. Press **<ENTER>** to measure the reference solution.  
The measured value is checked for stability (automatic stability control). The display of the measured parameter flashes.  
The measured potential is defined as the zero point.  
or  
Press **<M>** to terminate the display of the zero point.
7. Rinse the ORP electrode and immerse it in the test sample.  
The measured value is checked for stability (automatic stability control). The display of the measured parameter flashes.
8. Wait for a stable measured value.  
The display of the measured parameter no longer flashes.

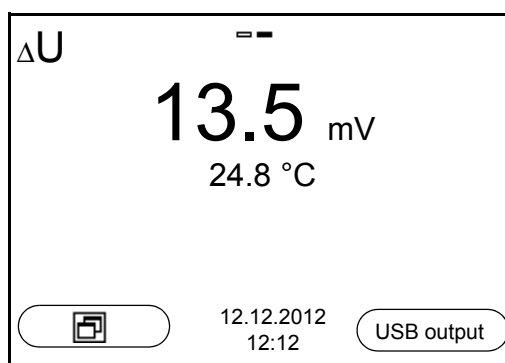

**AutoRead** The *Stability control* function checks whether the measured values are stable within the monitored time interval.

Measured parameter	Time interval	Stability in the time interval
ORP	15 seconds	$\Delta$ : better than 0.3 mV
Temperature	15 seconds	$\Delta$ : better than 0.5 °C

The minimum duration until a measured value is assessed as stable is the monitored time interval. The actual duration is mostly longer.

### 7.1.3 Measuring the temperature

For reproducible ORP measurements, it is essential to measure the temperature of the test sample.

You have the following options to measure the temperature:

- Automatic measurement of the temperature with the temperature sensor (NTC30 or Pt1000) integrated in electrode.
- Measurement by an external temperature sensor.
- Manual determination and input of the temperature.

The measuring instrument recognizes whether a suitable sensor is connected and automatically switches on the temperature measurement.

The display of the temperature indicates the active temperature measuring mode:

Temperature sensor	Resolution of the temp. display	Temp. measurement
yes	0.1 °C	Automatic with temperature sensor
-	1 °C	Manual

If you wish to measure (or calibrate) without temperature sensor, proceed as follows:

1. Measure the current temperature of the test sample.
2. In the **<MENU/ENTER>/U/Man. temperature** menu, set the temperature value with **<▲><▼>**.

## 7.2 ORP calibration



ORP electrodes are not calibrated. You can, however, check ORP electrodes by measuring the ORP of a test solution and comparing the value with the nominal value.

## 8 Ion concentration

### 8.1 Measuring

#### 8.1.1 Measuring the ion concentration

##### NOTE

When connecting an earthed PC/printer, measurements cannot be performed in earthed media as the values would be incorrect. The USB interface is not galvanically isolated.



Incorrect calibration of ion selective electrodes will result in incorrect measured values. Calibrate regularly before measuring.



For precise ISE measurements the temperature difference between measurement and calibration should not be greater than 2 K. Therefore, adjust the temperature of the standard and measuring solutions accordingly. If the temperature difference is greater the *[TpErr]* warning appears in the measured value display.

1. Connect the ISE combination electrode to the meter. The pH/ISE measuring window is displayed.
2. If necessary, select the ISE display (unit, mg/l) with **<M>**.
3. If necessary, measure the temperature of the test sample with a thermometer.
4. Calibrate or check the meter with the electrode.



While no valid calibration is available, e.g. in the delivery condition, "Error" appears in the measured value display.

5. Immerse the electrode in the test sample.

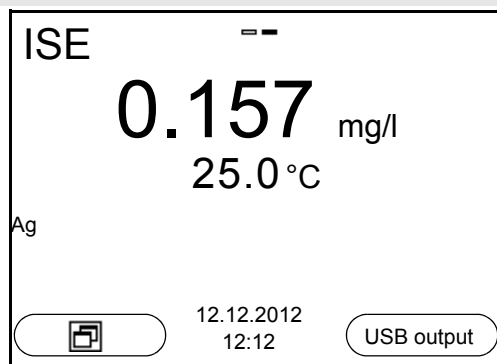

#### Stability control (AutoRead) & HOLD function

The stability control function (*AutoRead*) continually checks the stability of the measurement signal. The stability has a considerable impact on the reproducibility of measured values.

The measured parameter flashes on the display

- as soon as the measured value is outside the stability range
- when the automatic *Stability control* is switched off.

You can activate or switch off the automatic *Stability control* function (see section 9.3.1 SYSTEM, page 76).

1. Freeze the measured value with **<AR>**.  
The [HOLD] status indicator is displayed.  
The HOLD function is active.



You can terminate the *Stability control* function and the HOLD function with **<AR>** or **<M>** at any time.

2. Using **<ENTER>**, activate the *Stability control* function manually. The [AR] status indicator appears while the measured value is assessed as not stable. A progress bar is displayed and the display of the measured parameter flashes. The [HOLD][AR] status indicator appears as soon as a stable measured value is recognized. The progress bar disappears and the display of the measured parameter stops flashing. The current measurement data is output to the interface. Measurement data meeting the stability control criterion is marked by AR.



You can prematurely terminate the *Stability control* function manually with **<ENTER>** at any time. If the *Stability control* function is prematurely terminated, the current measurement data are output to the interface without the AutoRead info.

3. Using **<ENTER>**, start a further measurement with stability control.  
or  
Release the frozen measured value again with **<AR>** or **<M>**.  
The [AR] status display disappears. The display switches back to the previous indication.

**Criteria** The AutoRead criteria affect the reproducibility of the measured values. The following criteria can be adjusted:

- *high*: highest reproducibility
- *medium*: medium reproducibility
- *low*: lowest reproducibility



Increasing reproducibility also causes the response time to increase until a measured value is evaluated as stable.

### 8.1.2 Measuring the temperature

For reproducible ion-selective measurements, it is essential to measure the temperature of the test sample.

You have the following options to measure the temperature:

- Measurement by an external temperature sensor.
- Manual determination and input of the temperature.

The measuring instrument recognizes whether a suitable sensor is connected and automatically switches on the temperature measurement.

The display of the temperature indicates the active temperature measuring mode:

Temperature sensor	Resolution of the temp. display	Temp. measurement
yes	0.1 °C	Automatic with temperature sensor
-	1 °C	Manual

If you wish to measure (or calibrate) without temperature sensor, proceed as follows:

1. Measure the current temperature of the test sample.
2. In the **<MENU/ENTER>/ISE/Man. temperature** menu, set the temperature value with **<▲><▼>**.

## 8.2 Calibration

### 8.2.1 Why calibrate?

Ion-selective electrodes age and are temperature-dependent. This changes the slope. As a result, an inexact measured value is displayed. Calibration determines the calibration line of the electrode and stores this value in the meter.

Thus, you should calibrate before each measurement and at regular intervals.

### 8.2.2 When to calibrate?

- Before any measurement if possible
- After connecting another ISE electrode
- When the sensor symbol flashes, e.g. after a voltage interruption (empty batteries)

### 8.2.3 Calibration (ISE Cal)

ISE Cal is the conventional **two-point to seven-point calibration procedure** that uses 2 to 7 freely selectable standard solutions. The concentration expected for the measurement determines the concentration of the calibration standards.

1. Connect the ISE combination electrode to the meter. The pH/mV/ISE measuring window is displayed.
2. Keep the standard solutions ready.
3. If necessary, measure the temperature of the standard solutions with a thermometer.
4. If necessary, change the unit of the measurement result and calibration standards in the *ISE setup/Unit* menu.
5. In the measured value display, select the ISE measuring window with <▲> <▼> and <M>.
6. Start the calibration with <CAL>. The calibration display appears.

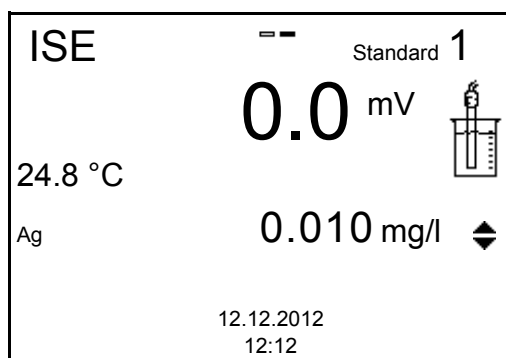



7. Thoroughly rinse the electrode with distilled water.
8. Immerse the electrode in standard solution 1.
9. When calibrating without temperature sensor:
  - Measure the temperature of the standard solution using a thermometer.
  - Use <F2>/[ T ↕ C ] to select the setting of the temperature.
  - Use <▲> <▼> to set the temperature.
  - Use <F2>/[ T ↕ C ] to select the setting of the concentration.
10. Set the concentration of the standard solution with <▲> <▼> and press <MENU/ENTER>. The standard solution is measured. The measured value is checked for stability (AutoRead).

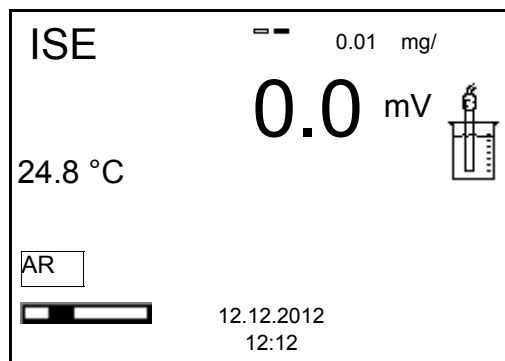

11. Wait for the end of the AutoRead measurement or accept the calibration value with <MENU/ENTER>. The calibration display for the next standard solution appears.

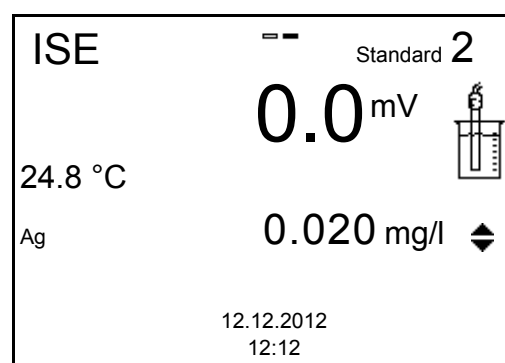

**Continuing with two-point calibration**

- |     |  |
|-----|--|
| 12. | Thoroughly rinse the electrode with distilled water. |
| 13. | Immerse the electrode in standard solution 2.        |

14. When calibrating without temperature sensor:
  - Measure the temperature of the standard solution using a thermometer.
  - Use <F2>/[ T ↕ C ] to select the setting of the temperature.
  - Use <▲> <▼> to set the temperature.
  - Use <F2>/[ T ↕ C ] to select the setting of the concentration.
15. Set the concentration of the standard solution with <▲> <▼> and press <MENU/ENTER>. The standard solution is measured. The measured value is checked for stability (AutoRead).

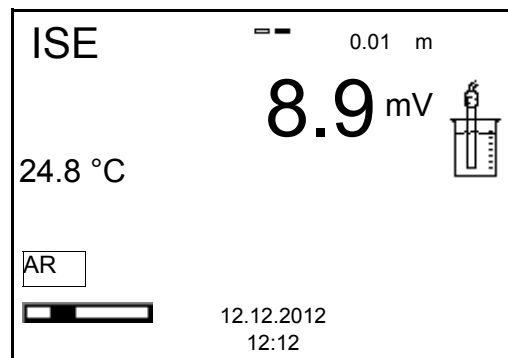

16. Wait for the end of the AutoRead measurement or accept the calibration value with <MENU/ENTER>. The calibration display for the next standard solution appears.

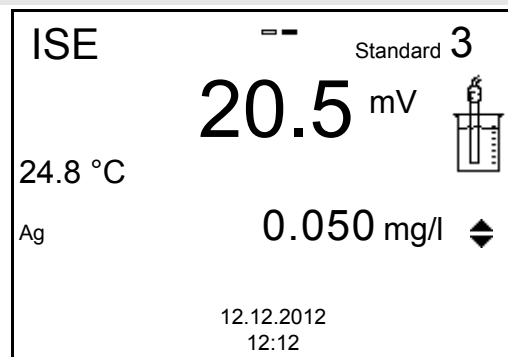

17. Press <MENU/ENTER> to continue with three-point calibration. or Finish the calibration procedure as a two-point calibration with <M>. The new calibration values are displayed.

**Continuing with three- to seven-point calibration**

Repeat the steps 8 to 13 in the same way with the third and further standard solutions as necessary. The new calibration values are displayed after the last calibration step was completed.



Based on the calibration data, the calibration curve is determined in sections, according to the Nernst equation modified by Nikolski.

### 8.2.4 Calibration standards

Use two to seven different standard solutions. The standard solutions have to be selected in either increasing or decreasing order.



Select the unit of the standard solution and measurement result in the *ISE setup/Unit* menu.

Standard solution (Std 1 - 7)	Values
Unit [mg/l]	0.010 ... 500,000
Unit [mol/l]	0.100 ... 5,000 µmol/l 10.00 ... 5,000 mmol/l
Unit [mg/kg]	0.010 ... 500,000
Unit [ppm]	0.010 ... 500,000
Unit [%]	0.001 ... 50,000



The measurement precision is also dependent on the selected standard solutions. Therefore, the selected standard solutions should cover the value range expected of the subsequent concentration measurement.

If the measured electrode potential is outside the calibrated range, the *[ISEErr]* warning is displayed.

### 8.2.5 Calibration data

#### Displaying the calibration data

The calibration record of the last calibration is to be found under the menu item, **<MENU/ENTER>** / *Calibration* / / *Calibration record*. To open it, press the **<CAL\_\_>** key in the measured value display.



Subsequently, you can transmit the displayed calibration data to the interface, e. g. to a PC, with **<F2>***[USB output]*.

#### Displaying the calibration data storage

The calibration records of the last calibrations (up to 10) are given in the menu, **<MENU/ENTER>**/ *ISE* / *Calibration* / *Calibration data storage*.

Menu item	Setting/function	Description
<i>Calibration / Calibration data storage / Display</i>	-	Displays the calibration record.  Further options: <ul style="list-style-type: none"> <li>● Scroll through the calibration records with &lt;▲&gt;&lt;▼&gt;.</li> <li>● Output the displayed calibration record to the interface with &lt;F2&gt;/[USB output].</li> <li>● Quit the display with &lt;F1&gt;/[Back] or &lt;MENU/ENTER&gt;.</li> <li>● Switch directly to the measured value display with &lt;M&gt;.</li> </ul>
<i>Calibration / Calibration data storage / Output to USB</i>	-	Outputs the calibration records to the interface.

**Calibration evaluation** After calibrating, the meter automatically evaluates the calibration.

Display	Calibration record	Calibration evaluation	Magnitude of the slope [mV]
	+++	<b>Ideal</b>	50.0 ... 70.0 * or 25.0 ... 35.0 **
	-	<b>Poor</b> (measurement accuracy restricted) <ul style="list-style-type: none"> <li>● Eliminate sources of error (see section 13.2 ISE, page 91).</li> <li>● Recalibrate</li> </ul>	30.0 ... 50.0 or 70.0 ... 90.0 * or 15.0 ...25.0 or 35.0 ... 45.0 **
<i>Error</i>	<i>Error</i>	<b>Insufficient</b> (measuring not possible) Error elimination (see section 13.2 ISE, page 91)	< 30 or > 90.0 * or < 15 or > 45 **

\* monovalent ions  
 \*\* divalent ions

**Calibration record  
(example)**

TruLab pH/ISE 1320  
Ser. no. 12345678

CALIBRATION ISE  
18.01.2013 08:09:10

Sensor  
Ser. no. 12345678

Standard 1	0.010 mg/l
Standard 2	0.020 mg/l
Voltage 1	38.5 mV
Voltage 2	58.0 mV
Temperature 1	24.0 °C
Temperature 2	24.0 °C
Ion type	Ag
Slope	64.7 mV
Sensor	+++

### 8.3 Selecting the measuring method

The following methods are supported:

- *Standard addition*
- *Standard subtraction*
- *Sample addition*
- *Sample subtraction*
- *Blank value addition*

1. Connect the ISE combination electrode to the meter. The pH/ISE measuring window is displayed.
2. If necessary, select the ISE display (unit, mg/l) with **<M>**.
3. If necessary, measure the temperature of the test sample with a thermometer.
4. Open the ISE menu with **<MENU/ENTER>**.
5. Thoroughly rinse the electrode with distilled water.
6. Adjust the temperature of the standard solutions.
7. Select *Method* with **<▲>** **<▼>** and confirm with **<MENU/ENTER>**.
8. Select a method with **<▲>** **<▼>** and confirm with **<MENU/ENTER>**.

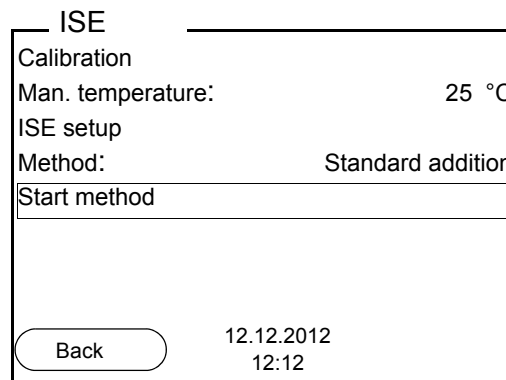

9. Select *Start method* with **<▲>** **<▼>** and confirm with **<MENU/ENTER>**. Measurement with the selected method begins (see section 8.3.1 STANDARD ADDITION, page 55 ... section 8.3.5 STANDARD ADDITION WITH BLANK VALUE CORRECTION (BLANK VALUE ADDITION), page 64).

### 8.3.1 Standard addition

In the "Standard addition" procedure, a known amount of standard solution is added to the sample.

The ion concentration in the sample is calculated from the change in potential.

1. Select the measuring method (see section 8.3 SELECTING THE MEASURING METHOD, page 54).
2. Prepare two standard calibration solutions.
3. Perform a two-point calibration according to user guidance.
4. The calibration record is displayed as soon as a stable value is achieved for the second standard calibration solution.

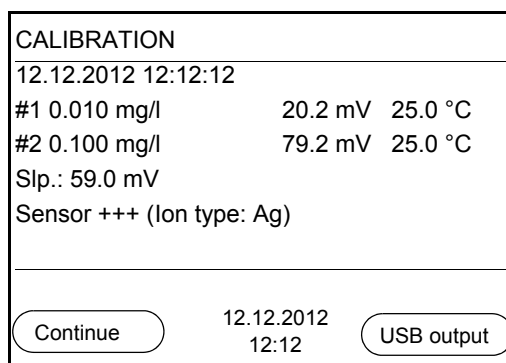

### Measuring

5. Start the measurement with <F1>/[Continue]. An entry window appears.

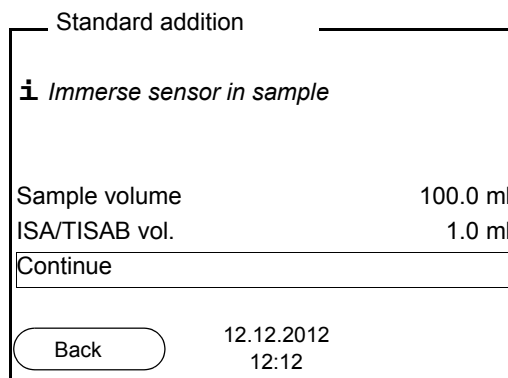

6. Prepare the sample.
7. If necessary, add the ISA/TISAB solution to the sample.
8. Thoroughly rinse the electrode with deionized water.
9. Immerse the electrode in the sample.
10. Using <▲> <▼> and <MENU/ENTER>, select the values for the volume of the sample (*Sample volume*) and the volume of the ISA/TISAB solution (*ISA/TISAB vol.*).

11. Select *Continue* with **<▲>** **<▼>** and start the measurement with **<MENU/ENTER>**.  
When the measurement is finished an entry window appears.

Standard addition

**i** Add standard!

Std. volume 1.0 ml  
Std. conc. 1.0 mg/l

Continue

Back 12.12.2012  
12:12

12. Add the standard solution to the sample.
13. Using **<▲>** **<▼>** and **<MENU/ENTER>**, enter the values for the volume of the standard solution (*Std. volume*) and concentration of the standard solution (*Std. conc.*) .
14. Select *Continue* with **<▲>** **<▼>** and start the measurement with **<MENU/ENTER>**.  
The measurement result is displayed when the measurement is completed.

ISE Standard addition

0.321 mg/l

24.8 °C

Ag

12.12.2012  
12:12 USB output

15. If necessary, start measuring further samples with **<MENU/ENTER>**.  
Repeat steps 6 - 14 for all samples.
16. Terminate the measuring method with **<M>**.  
A safety query appears.
17. Select Yes with **<▲>** **<▼>**.
18. Confirm Yes with **<MENU/ENTER>**.  
Measurement with the selected method is completed.



### 8.3.2 Standard subtraction

In the "Standard Subtraction" procedure, a known amount of standard solution is added to the sample (as complexing agent or precipitating agent) and, thus, the ion concentration lowered.

The ion concentration in the sample is calculated from the change in potential.

1. Select the measuring method (see section 8.3 SELECTING THE MEASURING METHOD, page 54).

#### Calibration

2. Prepare two standard calibration solutions.
3. Perform a two-point calibration according to user guidance.
4. The calibration record is displayed as soon as a stable value is achieved for the second standard calibration solution.

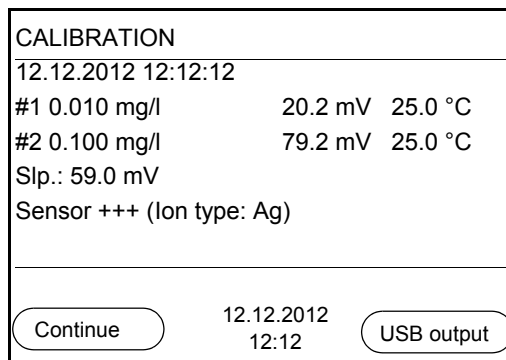

#### Measuring

5. Start the measurement with <F1>/[Continue]. An entry window appears.

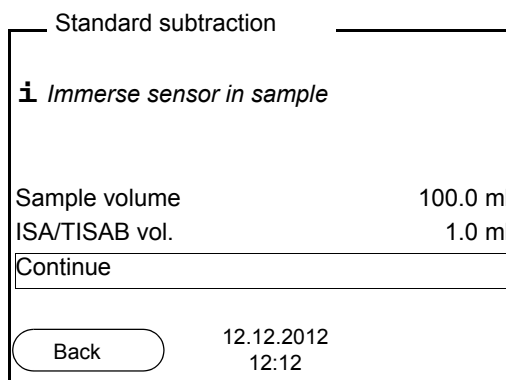

6. Prepare the sample.
7. If necessary, add the ISA/TISAB solution to the sample.
8. Thoroughly rinse the electrode with deionized water.
9. Immerse the electrode in the sample.

10. Using **<▲>** **<▼>** and **<MENU/ENTER>**, select the values for the volume of the sample (*Sample volume*) and the volume of the ISA/TISAB solution (*ISA/TISAB vol.*).
11. Select *Continue* with **<▲>** **<▼>** and start the measurement with **<MENU/ENTER>**.  
When the measurement is finished an entry window appears.

Standard subtraction

**i** Add standard!

Ion type	S
Std. volume	1.0 ml
Std. conc.	1.0 mg/l
Continue	

Back

12.12.2012  
12:12

12. Add the standard (complexing agent or precipitating agent) to the sample.
13. Using **<▲>** **<▼>** and **<MENU/ENTER>**, enter the values for the volume of the standard solution (*Std. volume*) and concentration of the standard solution (*Std. conc.*) .
14. If necessary, set the ion type for the ion in the standard (*Ion type*) with **<▲>** **<▼>** and **<MENU/ENTER>**.  
On selection of the ion type that can be defined (ION):  
Using **<▲>** **<▼>** and **<MENU/ENTER>**, set the valency (*Valency*) and molar weight (*Molar mass*) for the ion in the standard solution.
15. Select *Continue* with **<▲>** **<▼>** and start the measurement with **<MENU/ENTER>**.  
The measurement result is displayed when the measurement is completed.

ISE
Standard subtraction

0.321 mg/l

24.8 °C

Ag

12.12.2012  
12:12

USB output

16. If necessary, start measuring further samples with **<MENU/ENTER>**. Repeat steps 6 - 13 for all samples.
17. Terminate the measuring method with **<M>**.  
A safety query appears.

- 
- |     |  |
|-----|--|
| 18. | Select Yes with <▲> <▼>.   |
| 19. | Confirm Yes with <MENU/ENTER>.<br>Measurement with the selected method is completed. |

### 8.3.3 Sample addition

In the "Sample addition" procedure, a known amount of sample is added to the standard solution.

The ion concentration in the sample is calculated from the change in potential.

1. Select the measuring method (see section 8.3 SELECTING THE MEASURING METHOD, page 54).

#### Calibration

2. Prepare two standard calibration solutions.
3. Perform a two-point calibration according to user guidance.
4. The calibration record is displayed as soon as a stable value is achieved for the second standard calibration solution.

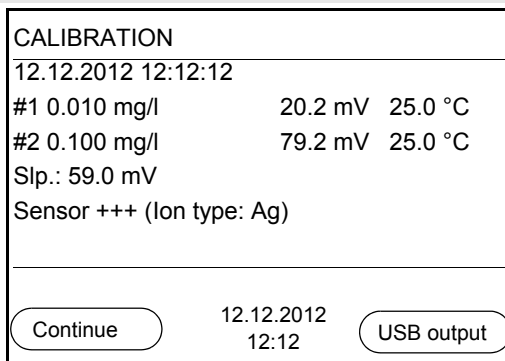

#### Measuring

5. Start the measurement with <F1>/[Continue]. An entry window appears.

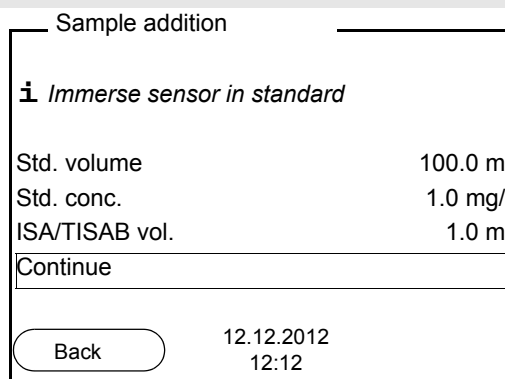

6. Prepare the standard solution.
7. If necessary, add the ISA/TISAB solution to the standard solution.
8. Thoroughly rinse the electrode with deionized water.
9. Immerse the electrode in the standard.
10. Using <▲> <▼> and <MENU/ENTER>, enter the values for the volume of the standard solution (*Std. volume*), the concentration of the standard solution (*Std. conc.*) and the volume of the ISA/TISAB solution (*ISA/TISAB vol.*).

11. Select *Continue* with  $\blacktriangle$   $\blacktriangledown$  and start the measurement with **<MENU/ENTER>**.  
When the measurement is finished an entry window appears.

Sample addition

**i** Add sample!

Sample volume 1.0 ml

Continue

Back 12.12.2012

12:12

12. Add the sample to the standard solution.
13. Using  $\blacktriangle$   $\blacktriangledown$  and **<MENU/ENTER>**, enter the value for the volume of the sample (*Sample volume*).
14. Select *Continue* with  $\blacktriangle$   $\blacktriangledown$  and start the measurement with **<MENU/ENTER>**.  
The measurement result is displayed when the measurement is completed.

ISE Sample addition

0.321 mg/l

24.8 °C

Ag

12.12.2012 USB output

12:12

15. If necessary, start measuring further samples with **<MENU/ENTER>**.  
Repeat steps 6 - 12 for all samples.
16. Terminate the measuring method with **<M>**.  
A safety query appears.
17. Select Yes with  $\blacktriangle$   $\blacktriangledown$ .
18. Confirm Yes with **<MENU/ENTER>**.  
Measurement with the selected method is completed.

### 8.3.4 Sample subtraction

With the "Sample subtraction" procedure, a known amount of sample is added to the standard solution (complexing agent or precipitating agent).

The ion concentration in the sample is calculated from the change in potential. The sample subtraction is one method for the indirect determination of ions. It is used for the determination of ions for which no direct determination is possible.

1. Select the measuring method (see section 8.3 SELECTING THE MEASURING METHOD, page 54).

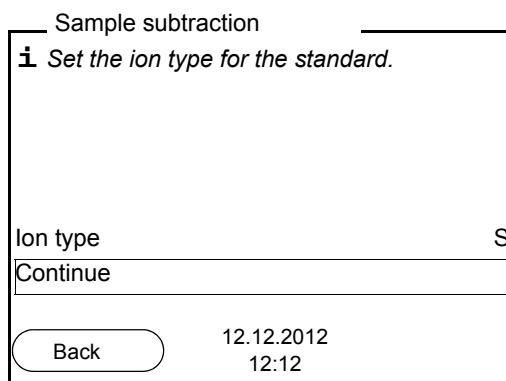

2. If necessary, set the ion type for the ion in the standard (*Ion type (sub)*) with **<▲>** **<▼>** and **<MENU/ENTER>**.  
On selection of the ion type that can be defined (ION):  
Using **<▲>** **<▼>** and **<MENU/ENTER>**, set the valency (*Valency*) and molar weight (*Molar mass*) for the ion in the standard solution.
3. Select *Continue* with **<▲>** **<▼>** and confirm with **<MENU/ENTER>**.

### Calibration

4. Prepare two standard calibration solutions.
5. Perform a two-point calibration according to user guidance.
6. The calibration record is displayed as soon as a stable value is achieved for the second standard calibration solution.

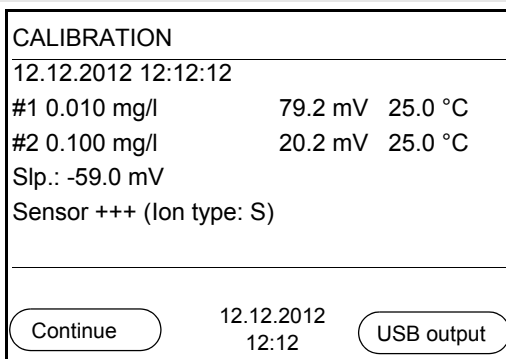

Measuring

7. Start the measurement with **<F1>** *Continue*. An entry window appears.

Sample subtraction

**i** *Immerse sensor in standard*

Std. volume 100.0 ml  
 Std. conc. 1.0 mg/l  
 ISA/TISAB vol. 1.0 ml

Continue

Back 12.12.2012  
12:12

8. Prepare the standard solution.

9. If necessary, add the ISA/TISAB solution to the standard solution.

10. Thoroughly rinse the electrode with deionized water.

11. Immerse the electrode in the standard solution (complexing agent or precipitating agent).

12. Using **<▲>** **<▼>** and **<MENU/ENTER>**, enter the values for the volume of the standard solution (*Std. volume*), the concentration of the standard solution (*Std. conc.*) and the volume of the ISA/TISAB solution (*ISA/TISAB vol.*).

13. Select *Continue* with **<▲>** **<▼>** and start the measurement with **<MENU/ENTER>**. When the measurement is finished an entry window appears.

Sample subtraction

**i** *Add sample!*

Sample volume 1.0 ml

Continue

Back 12.12.2012  
12:12

14. Add the sample to the standard (complexing agent or precipitating agent).

15. Using **<▲>** **<▼>** and **<MENU/ENTER>**, enter the value for the volume of the sample (*Sample volume*).

16. Select *Continue* with **<▲>** **<▼>** and start the measurement with **<MENU/ENTER>**. The measurement result is displayed when the measurement is completed.

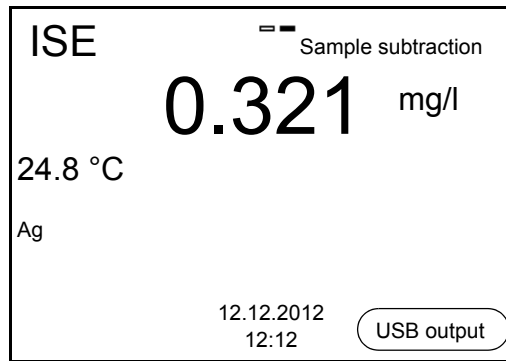

- |     |   |
|-----|---|
| 17. | If necessary, start measuring further samples with <b>&lt;MENU/ENTER&gt;</b> . Repeat steps 8 - 16 for all samples. |
| 18. | Terminate the measuring method with <b>&lt;M&gt;</b> . A safety query appears.                                      |
| 19. | Select Yes with <b>&lt;▲&gt;</b> <b>&lt;▼&gt;</b> .   |
| 20. | Confirm Yes with <b>&lt;MENU/ENTER&gt;</b> . Measurement with the selected method is completed.                     |

**8.3.5 Standard addition with blank value correction (*Blank value addition*)**

In the "Standard addition with blank value correction" procedure, a known amount of standard solution is added to the sample in two steps.

With the first addition, the ion concentration is raised to the linear range of the electrode characteristic curve.

The second addition is equivalent to the standard addition. The ion concentration in the sample is calculated from the change in potential.

1. Select the measuring method (see section 8.3 SELECTING THE MEASURING METHOD, page 54).

**Calibration**

- |    |   |
|----|---|
| 2. | Prepare two standard calibration solutions.   |
| 3. | Perform a two-point calibration according to user guidance.   |
| 4. | The calibration record is displayed as soon as a stable value is achieved for the second standard calibration solution. |



CALIBRATION		
12.12.2012 12:12:12		
#1 0.010 mg/l	20.2 mV	25.0 °C
#2 0.100 mg/l	79.2 mV	25.0 °C
Slp.: 59.0 mV		
Sensor +++ (Ion type: Ag)		
Continue	12.12.2012 12:12	USB output

**Measuring**

5. Start the measurement with **<F1> Continue**  
An entry window appears.

Blank value addition	
<b>i</b> Immerse sensor in sample	
Sample volume	100.0 ml
ISA/TISAB vol.	1.0 ml
BV volume	100.0 ml
BV conc.	1.000 mg/l
Continue	
Back	12.12.2012 12:12

6. Prepare the sample.
7. If necessary, add the ISA/TISAB solution to the sample.
8. Thoroughly rinse the electrode with deionized water.
9. Immerse the electrode in the sample that was supplemented with blank value solution.
10. Using **<▲>** **<▼>** and **<MENU/ENTER>**, enter the values for the volume of the sample (*Sample volume*), the volume of the ISA/TISAB solution (*ISA/TISAB vol.*), the volume of the blank value solution (*BV volume*) and the concentration of the blank value solution (*BV conc.*).
11. Select *Continue* with **<▲>** **<▼>** and start the measurement with **<MENU/ENTER>**.  
When the measurement is finished an entry window appears.

Blank value addition	
<b>i</b> Add standard!	
Std. volume	100.0 ml
Std. conc.	1.0 mg/l
Continue	
Back	12.12.2012 12:12

- |     |   |
|-----|---|
| 12. | Add the standard solution to the sample.  |
| 13. | Using <▲> <▼> and <MENU/ENTER>, enter the values for the volume of the standard solution ( <i>Std. volume</i> ) and concentration of the standard solution ( <i>Std. conc.</i> ). |
| 14. | Select <i>Continue</i> with <▲> <▼> and start the measurement with <MENU/ENTER>. The measurement result is displayed when the measurement is completed.                           |

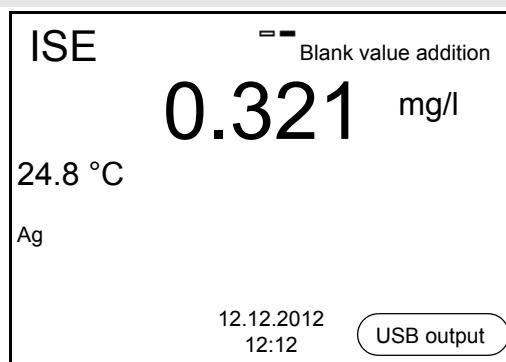

- |     |   |
|-----|---|
| 15. | If necessary, start measuring further samples with <MENU/ENTER>. Repeat steps 6 - 14 for all samples. |
| 16. | Terminate the measuring method with <M>. A safety query appears.                                      |
| 17. | Select Yes with <▲> <▼>.  |
| 18. | Confirm Yes with <MENU/ENTER>. Measurement with the selected method is completed.                     |

## 9 Settings

### 9.1 Measurement settings

#### 9.1.1 Settings for pH measurements

The settings for pH measurements are made in the menu for calibration and measurement settings of the pH/ORP measurement. To open the settings, display the required measured parameter in the measured value display and press the **<MENU/ENTER>** key. After completing the settings, switch to the measured value display with **<M>**.

In the following table, only those settings are listed that concern the pH measurement.

Default settings are printed in **bold**.

Menu item	Possible setting	Description
<i>Calibration / Calibration record</i>	-	Displays the calibration record of the last calibration.
<i>Calibration / Calibration data storage / Display</i>	-	Displays the calibration record.  Further options: <ul style="list-style-type: none"> <li>● Scroll through the calibration records with <b>&lt;▲&gt;&lt;▼&gt;</b>.</li> <li>● Output the displayed calibration record to the interface with <b>&lt;F2&gt;/[USB output]</b>.</li> <li>● Output all calibration records to the interface with <b>&lt;F2__&gt;/[USB output]</b>.</li> <li>● Quit the display with <b>&lt;F1&gt;/[Back]</b> or <b>&lt;MENU/ENTER&gt;</b>.</li> <li>● Switch directly to the measured value display with <b>&lt;M&gt;</b>.</li> </ul>
<i>Calibration / Calibration data storage / Output to USB</i>	-	Outputs the calibration records to the interface.

Menu item	Possible setting	Description
<i>Calibration/ Serial number (sensor)</i>	-	Entry of the series number of the connected sensor. The series number is output in the calibration record.  <ul style="list-style-type: none"> <li>● Change the contents of the highlighted position with &lt;▲&gt;&lt;▼&gt;.</li> <li>● Go to the next digit with &lt;F2&gt;/[▶].</li> <li>● After the series number was completely entered, confirm with &lt;ENTER&gt;.</li> </ul>
<i>Calibration /Buffer</i>	<b>YSI</b> <b>ConCal</b> <b>NIST/DIN</b> ...	Buffer sets to be used for pH calibration (see section 6.2 CALIBRATION, page 31).
<i>Calibration /One point calibration</i>	<b>Yes</b> <b>No</b>	Quick calibration with 1 buffer
<i>Calibration /Calibration interval</i>	1 ... 7 ... 999 d	<i>Calibration interval</i> for the pH electrode (in days). The meter reminds you to calibrate regularly by the flashing sensor symbol in the measuring screen.
<i>Calibration /Unit for slope</i>	<b>mV/pH</b> <b>%</b>	Unit of the slope. The % display refers to the Nernst slope of -59.2 mV/pH (100 x determined slope/Nernst slope).
<i>Alternative temperature</i>	<b>On</b> <b>Off</b>	Takes the temperature value from the 2nd sensor.
<i>Man. temperature</i>	-25 ... +25 ... +130 °C	Entry of the manually determined temperature. For measurements without temperature sensor only.
<i>Resolution pH</i>	<b>0.001</b> 0.01 0.1	Resolution of the pH display
<i>Limit monitoring</i>		With the <i>Limit monitoring</i> function you define the measured values whose exceeding is signaled. An acoustic signal sounds, and at the same time a message is output to the USB interface. You can switch on or off the acoustic signal in the <i>System</i> menu (see section 9.3.1 SYSTEM, page 76).

Menu item	Possible setting	Description
<i>Limit monitoring/ pH monitoring</i>	<i>On Off</i>	Switch on or off the limit signaling device for the pH value.
<i>Limit monitoring/ TP monitoring</i>	<i>On Off</i>	Switch on or off the limit signaling device for the temperature value.
<i>Limit monitoring/ pH monitoring/ On/ pH upper limit</i>	-2 ... 20	Upper limit. A message is output to the USB interface if it is exceeded. This menu item is only visible when the <i>pH monitoring</i> setting is active.
<i>Limit monitoring/ pH monitoring/ On/ pH lower limit</i>	-2 ... 20	Lower limit. A message is output to the USB interface if it is exceeded. This menu item is only visible when the <i>pH monitoring</i> setting is active.
<i>Limit monitoring/ TP monitoring/ On/ TP upper limit</i>	-5 ... +105 °C	Upper limit. A message is output to the USB interface if it is exceeded. This menu item is only visible when the <i>TP monitoring</i> setting is active.
<i>Limit monitoring/ TP monitoring/ On/ TP lower limit</i>	-5 ... 105 °C	Lower limit. A message is output to the USB interface if it is exceeded. This menu item is only visible when the <i>TP monitoring</i> setting is active.
<i>Reset</i>	-	Resets all sensor settings to the delivery condition (see section 9.4.1 RESETTING THE MEASUREMENT SETTINGS, page 77).

### 9.1.2 Buffer sets for calibration

You can use the buffer sets quoted in the table for an automatic calibration. The pH values are valid for the specified temperature values. The temperature dependence of the pH values is taken into consideration during the calibration.

No.	Buffer set *	pH values	at
1	YSI *	4.000 7.000 10.000	25 °C
2	ConCal	Any	Any
3	NIST/DIN DIN buffers according to DIN 19266 and NIST Traceable Buffers	1.679 4.006 6.865 9.180 12.454	25 °C

No.	Buffer set *	pH values	at
4	<i>TEC</i> Technical buffers	2.000 4.010 7.000 10.011	25 °C
5	<i>Merck 1*</i>	4.000 7.000 9.000	20°C
6	<i>Merck 2 *</i>	1.000 6.000 8.000 13.000	20°C
7	<i>Merck 3 *</i>	4.660 6.880 9.220	20°C
8	<i>Merck 4 *</i>	2.000 4.000 7.000 10.000	20°C
9	<i>Merck 5 *</i>	4.010 7.000 10.000	25 °C
10	<i>DIN 19267</i>	1.090 4.650 6.790 9.230	25 °C
11	<i>Mettler Toledo USA *</i>	1.679 4.003 7.002 10.013	25 °C
12	<i>Mettler Toledo EU *</i>	1.995 4.005 7.002 9.208	25 °C
13	<i>Fisher *</i>	2.007 4.002 7.004 10.002	25 °C
14	<i>Fluka BS *</i>	4.006 6.984 8.957	25 °C
15	<i>Radiometer *</i>	1.678 4.005 7.000 9.180	25 °C

No.	Buffer set *	pH values	at
16	<i>Baker</i> *	4.006 6.991 10.008	25 °C
17	<i>Metrohm</i> *	3.996 7.003 8.999	25 °C
18	<i>Beckman</i> *	4.005 7.005 10.013	25 °C
19	<i>Hamilton Duracal</i> *	4.005 7.002 10.013	25 °C
20	<i>Precisa</i> *	3.996 7.003 8.999	25 °C
21	<i>Reagecon TEC</i> *	2.000 4.010 7.000 10.000	25 °C
22	<i>Reagecon 20</i> *	2.000 4.000 7.000 10.000 13.000	20°C
23	<i>Reagecon 25</i> *	2.000 4.000 7.000 10.000 13.000	25 °C
24	<i>Chemsolute</i> *	2.000 4.000 7.000 10.000	20°C
25	<i>USABlueBook</i> *	4.000 7.000 10.000	25 °C

\* Brand names or trade names are trademarks of their respective owners protected by law.



The buffers are selected in the menu, pH / <MENU/ENTER> / Calibration / Buffer (see 9.1.1 SETTINGS FOR PH MEASUREMENTS, PAGE 67).

### 9.1.3 Calibration interval

The calibration evaluation is displayed as a sensor symbol.

The sensor symbol flashes after the adjusted calibration interval has expired. It is still possible to measure.



To ensure the high measuring accuracy of the measuring system, calibrate after the calibration interval has expired.

#### Setting the calibration interval

The calibration interval is set to 7 days in the factory. You can change the interval (1 ... 999 days):

1. Open the menu for measurement settings with **<MENU/ENTER>**.
2. In the *Calibration / Calibration interval* menu, set the calibration interval with **<▲><▼>**.
3. Confirm the setting with **<ENTER>**.
4. Quit the menu with **<M>**.



### 9.1.4 Settings for ORP measurements

The settings for ORP measurements are made in the menu for calibration and measurement settings of the pH/ORP measurement. To open the settings, display the required measured parameter in the measured value display and press the **<MENU/ENTER>** key. After completing the settings, switch to the measured value display with **<M>**.

In the following table, only those settings are listed that influence the ORP measurement.

Default settings are printed in **bold**.

Menu item	Possible setting	Description
<i>Alternative temperature</i>	<i>On</i> <b>Off</b>	Takes the temperature value from the 2nd sensor.
<i>Man. temperature</i>	-25 ... <b>+25</b> ... +130 °C	Entry of the manually determined temperature. For measurements without temperature sensor only.
<i>Resolution mV</i>	<b>0.1</b> 1	Resolution of the mV display
<i>Reset</i>	-	Resets all sensor settings to the delivery condition (see section 9.4.1 RESETTING THE MEASUREMENT SETTINGS, page 77).

## 9.2 Settings for ISE measurements

The settings are made in the measuring menu of the ISE measurement. To open the settings, activate the relevant measuring window in the measured value display and press the **<MENU/ENTER>** key shortly. After completing the settings, switch to the measured value display with **<M>**.

The following settings are possible for ISE measurements:

Menu item	Possible setting	Description
<i>Calibration / Calibration record</i>	-	Displays the calibration record of the last calibration.
<i>Calibration / Calibration data storage / Display</i>	-	<p>Displays the calibration record.</p> <p>Further options:</p> <ul style="list-style-type: none"> <li>● Scroll through the calibration records with <b>&lt;▲&gt;&lt;▼&gt;</b>.</li> <li>● Output the displayed calibration record to the interface with <b>&lt;F2&gt;/[USB output]</b>.</li> <li>● Output all calibration records to the interface with <b>&lt;F2__&gt;/[USB output]</b>.</li> <li>● Quit the display with <b>&lt;F1&gt;/[Back]</b> or <b>&lt;MENU/ENTER&gt;</b>.</li> <li>● Switch directly to the measured value display with <b>&lt;M&gt;</b>.</li> </ul>
<i>Calibration / Calibration data storage / Output to USB</i>	-	Outputs the calibration records to the interface.
<i>Calibration/ Serial number (sensor)</i>	-	<p>Entry of the series number of the connected sensor. The series number is output in the calibration record.</p> <ul style="list-style-type: none"> <li>● Change the contents of the highlighted position with <b>&lt;▲&gt;&lt;▼&gt;</b>.</li> <li>● Go to the next digit with <b>&lt;F2&gt;/[▶]</b>.</li> <li>● After the series number was completely entered, confirm with <b>&lt;ENTER&gt;</b>.</li> </ul>

Menu item	Possible setting	Description
<i>Alternative temperature</i>	<i>On</i> <i>Off</i>	Takes the temperature value from the 2nd sensor.
<i>Man. temperature</i>	-25 ... <b>+25</b> ... +130 °C	Entry of the manually determined temperature. For measurements without temperature sensor only.
<i>ISE setup / AutoRead criterion</i>	<i>low</i> <b><i>medium</i></b> <i>high</i>	Selection of the AutoRead criteria (see section 8.1.1 MEASURING THE ION CONCENTRATION, page 45).
<i>ISE setup / Ion type</i>	Ag, Br, Ca, Cd, Cl, CN, Cu, F, I, K, Na, NO <sub>3</sub> , Pb, S, NH <sub>3</sub> , NH <sub>4</sub> <sup>*</sup> , CO <sub>2</sub> , ION	Selection of the ion type to be measured.  An ion that is not included in the list can be measured with the setting, ION.
<i>ISE setup / Unit</i>	mg/l µmol/l mg/kg ppm %	Selection, with which unit the measurement result and calibration standards should be displayed.
<i>ISE setup / Ion type / ION</i>	<i>Valency</i> <i>Molar mass</i>	Set the valence ( <i>Valency</i> ) and molar weight ( <i>Molar mass</i> ) for the ion.
<i>ISE setup / Density</i>	0.001 ... 9.999 g/ml or kg/l	Adjustable density of the test sample (only with <i>Unit</i> : mg/kg, ppm, %)
<i>Method</i>	<i>Standard addition</i> <i>Standard subtraction</i> <i>Sample addition</i> <i>Sample subtraction</i> <i>Blank value addition</i>	Selection of the available measuring methods.
<i>Start method</i>		Start measurement with the selected method.

### 9.3 Sensor-independent settings

#### 9.3.1 System

To open the *Storage & config* menu, press the **<MENU/ENTER\_\_>** key in the measured value display. After completing the settings, switch to the measured value display with **<M>**.

Default settings are printed in **bold**.

Menu item	Possible setting	Description
<i>System / General / Language</i>	<i>Deutsch</i> <b>English</b> <i>(further)</i>	Selects the menu language
<i>System / General / Beep</i>	<b>On</b> <i>Off</i>	Switches on/off the beep on keystroke
<i>System / General / Illumination</i>	<b>Auto</b> <i>On</i> <i>Off</i>	Switches the display illumination on/off
<i>System / General / Contrast</i>	<i>0 ...</i> <b>50</b> <i>... 100</i> %	Changes the display contrast
<i>System / General / Switchoff time</i>	<i>10 min ...</i> <b>1h</b> <i>... 24 h</i>	Adjusts the switch-off time
<i>System / General / Temperature unit</i>	<b>°C</b> °F	Temperature unit, degrees Celsius or degrees Fahrenheit. All temperature values are displayed with the selected unit.
<i>System / General / Stability control</i>	<b>On</b> <i>Off</i>	Switches on or off the automatic stability control during measurement
<i>System / Interface / Baud rate</i>	<i>1200, 2400,</i> <b>4800</b> , <i>9600,</i> <i>19200</i>	Baud rate of the data interface
<i>System / Interface / Output format</i>	<b>ASCII</b> CSV	Output format for data transmission (see section 11 TRANSMITTING DATA (USB INTERFACE), page 85)
<i>System / Interface / Decimal separator</i>	<b>Dot (xx.x)</b> <i>Comma (xx,x)</i>	Decimal separator
<i>System / Interface / Output header</i>		Output of a header for <i>Output format: CSV</i>

Menu item	Possible setting	Description
<i>System / Printer</i>		Settings for the integrated printer of the TruLab pH/ISE 1320P. For details, see section 4 PRINTER (ONLY TRULAB PH/ISE 1320 P), page 14
<i>System / Clock</i>	<i>Date format</i> <i>Datum</i> <i>Time</i>	Time and date settings (see section 5.4.6 EXAMPLE 2 ON NAVIGATION: SETTING THE DATE AND TIME, page 25)
<i>System / Service information</i>		Hardware version and software version of the meter are displayed.
<i>System / Reset</i>	-	Resets the system settings to the delivery condition (see section 9.4.2 RESETTING THE SYSTEM SETTINGS, page 78).

### 9.3.2 Data storage

This menu contains all functions to display, edit and erase stored measured values and calibration records (see section 10 DATA STORAGE, page 79).

## 9.4 Reset

You can reset (initialize) all sensor settings and sensor-independent settings separately from each other.

### 9.4.1 Resetting the measurement settings



The calibration data are reset to the default settings together with the measuring parameters. Recalibrate after performing a reset.

The following settings for pH measurements are reset to the default settings with the *Reset* function:

pH	Setting	Default settings
	<i>Buffer</i>	YSI
	<i>Calibration interval</i>	7 d
	<i>Unit for slope</i>	mV/pH
	<i>Measured parameter</i>	pH

Setting	Default settings
Resolution pH	0.001
Resolution mV	0.1
Asymmetry	0 mV
Slope	-59.2 mV
<i>Man. temperature</i>	25 °C
<i>One point calibration</i>	No
Stability control	On
Temperature unit	°C

The sensor settings are reset under the *Reset* menu item in the menu for calibration and measurement settings. To open it in the measured value display, press the **<MENU/ENTER>** key.

#### 9.4.2 Resetting the system settings

The following system settings can be reset to the delivery status:

Setting	Default settings
<i>Language</i>	English
<i>Beep</i>	On
<i>Baud rate</i>	4800 Baud
<i>Output format</i>	ASCII
<i>Decimal separator</i>	Dot (xx.x)
<i>Contrast</i>	50 %
<i>Illumination</i>	Auto
<i>Switchoff time</i>	1 h

The system settings are reset in the menu, *Storage & config / System / Reset*. To open the *Storage & config* menu, press the **<MENU/ENTER\_\_>** key in the measured value display.

## 10 Data storage

You can transmit measured values (datasets) to the data storage:

- Manual data storage (see section 10.1 MANUAL DATA STORAGE, page 79)
- Automatic storage at intervals (see section 10.2 AUTOMATIC DATA STORAGE AT INTERVALS, page 80)

With each data storage process, the current datasets of the sensors indicated on the display are transmitted to the interface at the same time.

### 10.1 Manual data storage

You can transmit a measurement dataset to the data storage as follows. With each data storage process, the current datasets of the sensors indicated on the display are transmitted to the interface at the same time.

1. Press the **<STO>** key shortly.  
The menu for manual data storage appears.

The screenshot shows a rectangular menu box with a title bar at the top that reads "Manual data storage 4 von 200". Inside the box, the following information is displayed: the date and time "12.12.2012 11:24:16", and sensor readings "pH 7.000 24.8 °C AR +++". Below this, the text "ID number:" is followed by the value "1". A horizontal input field contains the word "Continue". At the bottom left, there is a rounded rectangular button labeled "Back". At the bottom right, the date and time "12.12.2012 12:12" are shown.

2. If necessary, change and confirm the ID number (1 ... 10000) with **<▲><▼>** and **<MENU/ENTER>**.  
The dataset is stored. The meter switches to the measured value display.

**If the storage is full** The following window appears if all 200 storage locations are occupied:

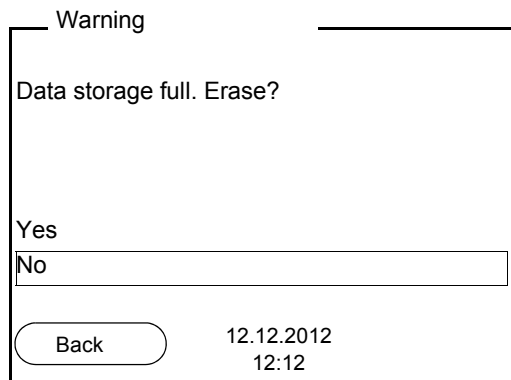

You have the following options:

- To erase the entire storage, confirm *Yes*.
- To cancel the storage process and switch to the measured value display, confirm *No*. Then you can e.g. transmit the stored data to a PC (see section 10.3.1 EDITING THE MEASUREMENT DATA STORAGE, page 82) and subsequently erase the data storage (see section 10.3.2 ERASING THE MEASUREMENT DATA STORAGE, page 84).

### 10.2 Automatic data storage at intervals

The storage interval (*Interval*) determines the time interval between automatic data storage processes. With each data storage process, the current datasets of the sensors indicated on the display are transmitted to the interface at the same time.

#### Configuring the automatic storage function

1. Press the <STO\_\_> key.  
The menu for automatic data storage appears.

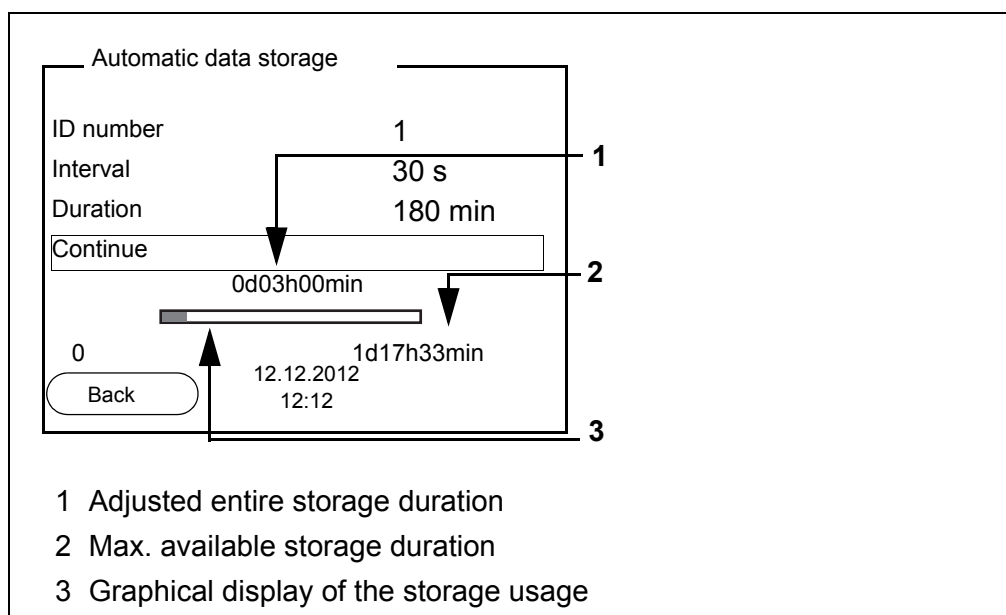

- 1 Adjusted entire storage duration
- 2 Max. available storage duration
- 3 Graphical display of the storage usage



**Settings** You can configure the automatic data storage function with the following settings:

Menu item	Possible setting	Description
<i>ID number</i>	1 ... 10000	ID number for the dataset series.
<i>Interval</i>	1 s, 5 s, 10 s, 30 s, 1 min, 5 min, 10 min, 15 min, 30 min, 60 min	Storage interval.  The lower limit of the storage interval can be restricted by the number of free storage locations. The upper limit is restricted by the storage duration.
<i>Duration</i>	1 min ... x min	Storage duration. Specifies after which time the automatic data storage should be terminated.  The lower limit of the storage duration is restricted by the storage interval. The upper limit is restricted by the number of free storage locations.

**Starting the automatic storage function**

To start the automatic storage function, select *Continue* with <▲><▼> and confirm with <MENU/ENTER>. The meter switches to the measured value display.

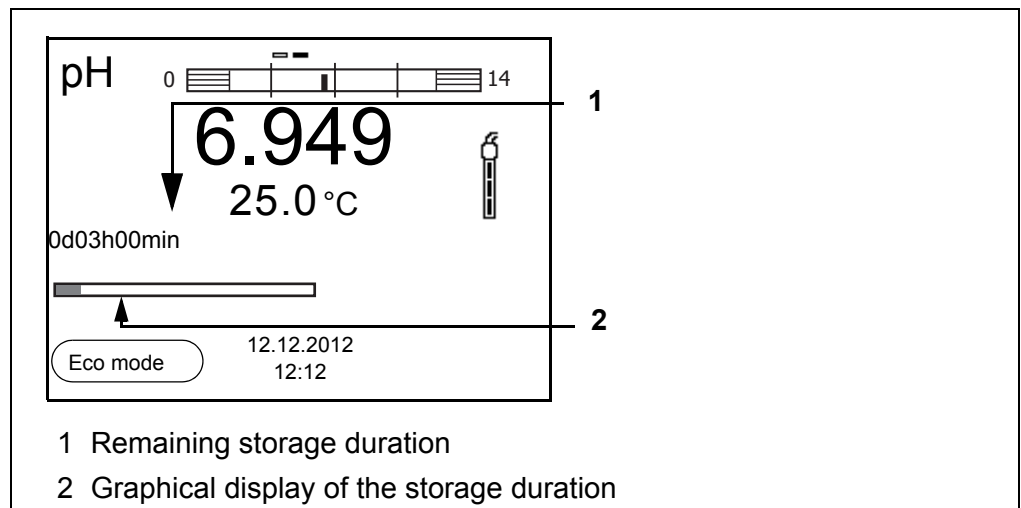

The active automatic storage function can be recognized by the progress bar in the function display. The progress bar indicates the remaining storage duration.



If the automatic storage function is activated, only the following keys are active: Softkeys, <M>, <STO\_\_> and <On/Off>. The other keys and the automatic switch-off function are deactivated.

**Energy saving mode  
([Eco mode])**

If the automatic storing function is active, the meter provides an energy saving mode ([Eco mode]) to avoid unnecessary energy consumption. The energy saving mode switches off functions of the meter that are not required for the automatic storage of measurement data (such as the display). By pressing any key the energy saving mode is switched off again.

**Terminating the  
automatic storage  
function  
prematurely**

Proceed as follows to switch off the automatic data storage function before the adjusted storage duration has expired:

1. Press the **<STO\_\_>** key.  
The following window appears.

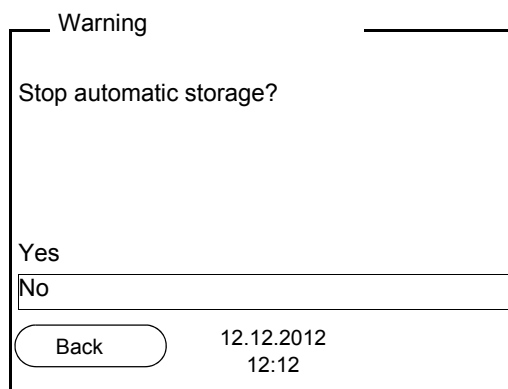

2. Using **<▲><▼>**, select Yes and confirm with **<MENU/ENTER>**.  
The meter switches to the measured value display.  
The automatic data storage function is terminated.

### 10.3 Measurement data storage

#### 10.3.1 Editing the measurement data storage

The contents of the manual or automatic measurement data storage can be shown on the display and output to the interface.

Each of the measurement data storages has a function to erase the entire contents.

**Editing the data  
storage**

The storage is edited in the menu, *Storage & config / Data storage*. To open the *Storage & config* menu, press the **<MENU/ENTER\_\_>** key in the measured value display.

Open the manual or automatic storage directly with the **<RCL>** or **<RCL\_\_>** key.



The settings are explained here using the manual data storage as an example. The same settings and functions are available for the automatic data storage.

**Settings**

Menu item	Setting/ function	Description
<i>Data storage / Manual data storage / Display</i>	-	Displays all measurement datasets page by page.  Further options: <ul style="list-style-type: none"> <li>● Scroll through the datasets with &lt;▲&gt;&lt;▼&gt;.</li> <li>● Output the displayed dataset to the interface with &lt;F2&gt;/[USB output].</li> <li>● Quit the display with &lt;F1&gt;/[Back].</li> </ul>
<i>Data storage / Manual data storage / Erase</i>	-	Erases the entire manual measurement data storage. All calibration data remain stored when this action is performed.
<i>Data storage / Manual data storage / Output to USB</i>	-	Outputs all stored measurement data to the interface.

**Display presentation of a dataset**

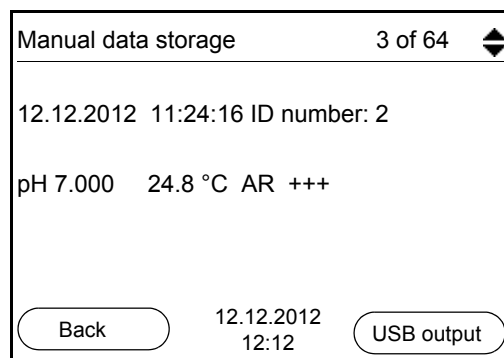

**Representation of a dataset (USB output)**

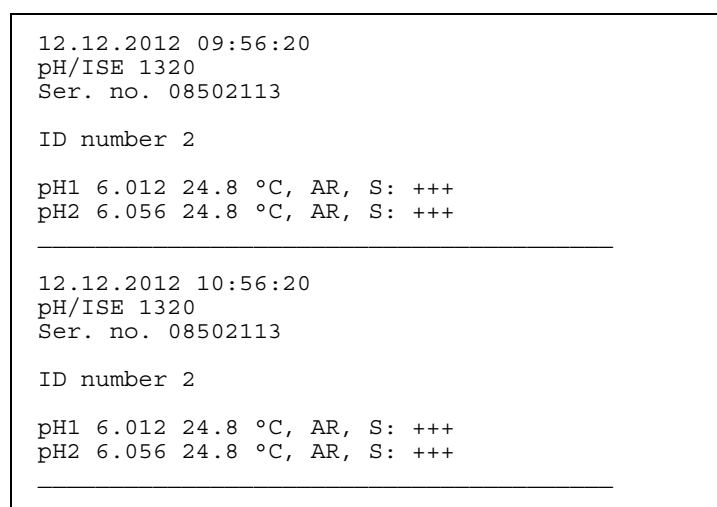

**Quitting the display**

To quit the display of stored measurement datasets, you have the following options:

- Switch directly to the measured value display with **<M>**.
- Quit the display and move to the next higher menu level with **<F1>/[Back]**.

**10.3.2 Erasing the measurement data storage**

Erasing the measurement data storage (see section 10.3.1 EDITING THE MEASUREMENT DATA STORAGE, page 82).

**10.3.3 Measurement dataset**

A complete dataset includes:

- ID number
- Date/time
- Measured values of the connected sensors
- Measured temperature value of the connected sensors or manually set temperature
- AutoRead info: The *AR* indicator appears with the measured value if the AutoRead criterion was met while storing (stable measured value). Otherwise, there is no *AR* indicator.
- Calibration evaluation: +++, ++, +, -, or no evaluation

**10.3.4 Storage locations**

The TruLab pH/ISE 1320 meter has two measurement data storages. The measured values recorded either manually or automatic are stored separately in individual measurement data storages.

<b>Storage</b>	<b>Maximum number of datasets</b>
<i>Manual data storage</i>	200
<i>Automatic data storage</i>	5000

## 11 Transmitting data (USB interface)

### 11.1 Options for data transmission

Via the USB interface you can transmit data to a PC. The following table shows which data are transmitted to the interface in which way:

Data	Control	Operation / description
Current datasets of the sensors indicated on the display	Manual	<ul style="list-style-type: none"> <li>● With <b>&lt;F2&gt;</b>/<i>[USB output]</i>.</li> <li>● Simultaneously with every manual data storage process (see section 10.1 MANUAL DATA STORAGE, page 79).</li> </ul>
	Automatic, at intervals	<ul style="list-style-type: none"> <li>● With <b>&lt;F2__&gt;</b>/<i>[USB output]</i>. Then you can set the transmission interval.</li> <li>● Simultaneously with every automatic data storage process (see section 10.2 AUTOMATIC DATA STORAGE AT INTERVALS, page 80).</li> </ul>
Stored measured values	Manual	<ul style="list-style-type: none"> <li>● Displayed dataset with <b>&lt;F2&gt;</b>/<i>[USB output]</i> after calling up from the storage.</li> <li>● All datasets with the <i>Output to USB</i> function. (see section 10.3.1 EDITING THE MEASUREMENT DATA STORAGE, page 82).</li> </ul>
Calibration records	Manual	<ul style="list-style-type: none"> <li>● Calibration record with <b>&lt;F2&gt;</b>/<i>[USB output]</i> (see section 6.2.6 CALIBRATION DATA, page 38).</li> </ul>
	Automatic	<ul style="list-style-type: none"> <li>● At the end of a calibration procedure.</li> </ul>



The following rule applies: With the exception of the menus, shortly pressing the **<F2>**/*[USB output]* key generally outputs the display contents to the interface (displayed measured values, measurement datasets, calibration records).

## 11.2 Connecting a PC

Connect the TruLab pH/ISE 1320 to the PC via the USB interface.

### **NOTE**

**When connecting an earthed PC/printer, measurements cannot be performed in earthed media as the values would be incorrect. The USB interface is not galvanically isolated.**

### **Installation of the USB driver on the PC**

System requirements of the PC for installation of the USB driver:

- PC with Pentium processor or higher with at least one free USB connection and CD-ROM drive
- Windows XP, Windows 7.

1. Insert the supplied installation CD in the CD drive of your PC.
2. Install the driver from the CD.  
Follow the Windows installation instructions as necessary.
3. Connect the TruLab pH/ISE 1320 to the PC via the USB interface.  
The meter is listed as a virtual COM interface among the connections in the Windows instrument manager.

## 11.3 MultiLab Importer

With the aid of the MultiLab Importer software, you can record and evaluate measurement data with a PC.



More detailed information can be found in the MultiLab Importer operating manual.

## 12 Maintenance, cleaning, disposal

### 12.1 Maintenance

#### 12.1.1 General maintenance activities

The only maintenance activity required is replacing the batteries.



See the relevant operating manuals of the electrodes for instructions on maintenance.

#### 12.1.2 Replacing the batteries



You can operate the meter either with normal batteries or with rechargeable batteries (Ni-MH). In order to charge the batteries, an external charging device is required.

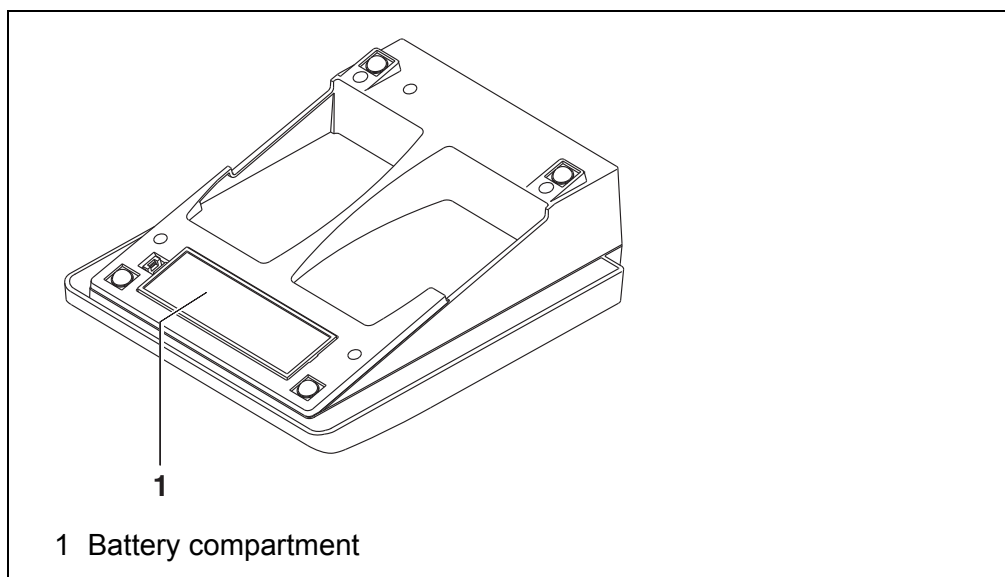

1. Open the battery compartment (1) on the underside of the meter.
2. Remove the four batteries from the battery compartment.
3. Place four new batteries (type Mignon AA) in the battery compartment.



#### **CAUTION**

**Make sure that the poles of the batteries are positioned correctly.**

**The  $\pm$  signs on the batteries must correspond to the  $\pm$  signs in the battery compartment.**

4. Close the battery compartment (1).
5. Set the date and time (see section 5.4.6 EXAMPLE 2 ON NAVIGATION: SETTING THE DATE AND TIME, page 25)



When the batteries are nearly discharged, the  status indicator is displayed.



Dispose of used batteries according to the local regulations of your country.

End users within the European Union are obligated to return used batteries (even ecologically compatible ones) to a collection point set up for recycling purposes.

Batteries are marked with the crossed-out waste container symbol. Therefore, they may not be disposed with the domestic waste.

## 12.2 Cleaning

Occasionally wipe the outside of the measuring instrument with a damp, lint-free cloth. Disinfect the housing with isopropanol as required.



### **CAUTION**

**The housing is made of synthetic material (ABS). Thus, avoid contact with acetone or similar detergents that contain solvents. Remove any splashes immediately.**

## 12.3 Packing

This meter is sent out in a protective transport packing. We recommend: Keep the packing material. The original packing protects the meter against damage during transport.

## 12.4 Disposal

At the end of its operational lifetime, the meter must be returned to the disposal or return system statutory in your country. If you have any questions, please contact your supplier.



## 13 What to do if...

### 13.1 pH/ORP



More information and instructions on cleaning and exchange of sensors are given in the documentation of your sensor.

#### Error message *OFL, UFL*

The measured value is outside the measuring range.

Cause	Remedy
pH electrode:	
– Air bubble in front of the junction	– Remove air bubble
– Air in the junction	– Extract air or moisten junction
– Cable broken	– Replace electrode
– Gel electrolyte dried out	– Replace electrode
– Measured value outside the measuring range	– Use suitable electrode

#### Error message, *Error*

Cause	Remedy
pH electrode:	
– The values determined for zero point and slope of the electrode are outside the allowed limits.	– Recalibrate
– Junction contaminated	– Clean junction
– Electrode broken	– Replace electrode
Buffer solutions:	
– Wrong buffer solutions	– Change calibration procedure
– Buffer solutions too old	– Use only once. Note the shelf life
– Buffer solutions depleted	– Change solutions

No stable measured value	Cause	Remedy
	pH electrode:	
	– Junction contaminated	– Clean the junction
	– Membrane contaminated	– Clean the membrane
	Test sample:	
	– pH value not stable	– Measure with air excluded if necessary
	– Temperature not stable	– Temper if necessary
	Electrode + test sample:	
	– Conductivity too low	– Use a suitable electrode
	– Temperature too high	– Use a suitable electrode
	– Organic liquids	– Use a suitable electrode
Obviously incorrect measured values	Cause	Remedy
	pH electrode:	
	– pH electrode unsuitable	– Use a suitable electrode
	– Temperature difference between buffer and test sample too great	– Adjust the temperature of buffer or sample solutions
	– Measurement procedure not suitable	– Follow a special procedure

## 13.2 ISE

Error message <i>OFL</i>	Cause	Remedy
	– Measuring range exceeded	– Dilute the test sample
Obviously incorrect measured values	Cause	Remedy
	– Electrode not connected	– Connect the electrode
	– Cable broken	– Replace the electrode
Error message, Error (invalid calibration) or Calibration evaluation poor (-)	Cause	Remedy
	<i>ISE electrode:</i>	
	– Moisture in the plug	– Dry the plug
	– Electrode is old	– Replace the electrode
	– Electrode not suitable for the range to be measured	– Use a suitable electrode
	– Electrode not suitable for the selected ion	– Use a suitable electrode or select a suitable ion
	– Socket damp	– Dry the socket
	– Electrode needs maintenance	– Use service and storage recommendations in the electrode manual. – Replace internal fill solution and/or the sensor module (if replaceable).
	– Refill hole is not open	– Open the refill hole (if equipped) during use
	– Electrode junction not in solution	– The outer junction should be completely immersed in standard or sample. – Level of internal fill solution (if refillable) must be higher than the level of standard or sample.
	<i>Calibration procedure:</i>	
	– Wrong sequence of standards for three point calibration	– Select the correct sequence
	– Calibration standards do not have the correct temperature (max. $\pm 2$ °C temperature difference)	– Adjust the temperature of the calibration standards

	<b>Cause</b>	<b>Remedy</b>
	<ul style="list-style-type: none"> <li>– Calibration standards not prepared correctly</li> </ul>	<ul style="list-style-type: none"> <li>– Prepare fresh and accurate standards. Use ionic strength adjustor (ISA).</li> <li>– Stir the solution with stir bar and plate.</li> </ul>
<b>Warning [TpErr]</b>	<b>Cause</b> <ul style="list-style-type: none"> <li>– Temperature difference between measurement and calibration greater than 2 °C.</li> </ul>	<b>Remedy</b> <ul style="list-style-type: none"> <li>– Adjust the temperature of the test sample</li> </ul>
<b>Warning [ISEErr]</b>	<b>Cause</b> <ul style="list-style-type: none"> <li>– Electrode voltage outside calibrated range</li> </ul>	<b>Remedy</b> <ul style="list-style-type: none"> <li>– Recalibrate</li> </ul>

### 13.3 General information

Sensor symbol flashes	<b>Cause</b> <ul style="list-style-type: none"> <li>– Calibration interval expired</li> </ul>	<b>Remedy</b> <ul style="list-style-type: none"> <li>– Recalibrate the measuring system</li> </ul>
 display	<b>Cause</b> <ul style="list-style-type: none"> <li>– Batteries almost empty</li> </ul>	<b>Remedy</b> <ul style="list-style-type: none"> <li>– Replace the batteries (see section 12.1 MAINTENANCE, page 87)</li> </ul>
Meter does not react to keystroke	<b>Cause</b> <ul style="list-style-type: none"> <li>– Operating condition undefined or EMC load unallowed</li> </ul>	<b>Remedy</b> <ul style="list-style-type: none"> <li>– Processor reset: Press the <b>&lt;ENTER&gt;</b> and <b>&lt;On/Off&gt;</b> key simultaneously</li> </ul>
You want to know which software version is in the meter	<b>Cause</b> <ul style="list-style-type: none"> <li>– E. g., a question by the service department</li> </ul>	<b>Remedy</b> <ul style="list-style-type: none"> <li>– Switch on the meter. Open the menu, <b>&lt;ENTER_&gt;</b> / <i>Storage &amp; config / System / Service information</i>. The instrument data are displayed.</li> </ul>

## 14 Technical data

### 14.1 Measuring ranges, resolution, accuracy

#### 14.1.1 pH/ORP

##### Measuring ranges, resolution

Parameter	Measuring range	Resolution
pH	-2.0 ... +20.0	0.1
	-2.00 ... +20.00	0.01
	- 2.000 ... + 19.999	0.001
U [mV]	-1200.0 ... +1200.0	0.1
	-2500 ... +2500	1
T [°C]	-5.0 ... +105.0	0.1
T [°F]	23.0 ... +221.0	0.1

##### Manual temperature input

Parameter	Range	Increment
T <sub>manual</sub> [°C]	-25 ... +130	1
T <sub>manual</sub> [°F]	-13 ... +266	1

##### Accuracy (± 1 digit)

Parameter	Accuracy	Temperature of the test sample
<b>pH / range *</b>		
-2.0 ... +20.0	± 0.1	+15 °C ... +35 °C
-2.00 ... +20.00	± 0.01	+15 °C ... +35 °C
- 2.000 ... + 19.999	± 0.005	+15 °C ... +35 °C
<b>U [mV] / range</b>		
-2500 ... +2500	± 1	+15 °C ... +35 °C
-1200.0 ... +1200.0	± 0.3	+15 °C ... +35 °C
<b>T [°C] / temperature sensor</b>		
NTC 30	± 0.1	
PT 1000	± 0.1	

\* when measuring in a range of ± 2 pH around a calibration point



The accuracy values specified here apply exclusively to the meter. The accuracy of the electrodes and buffer solutions has to be taken into account additionally.

## 14.1.2 ISE

Measuring ranges, resolution	Parameter	Measuring range	Resolution
	ISE [mg/l]	0.000 ... 9.999 10.00 ... 99.99 100.0 ... 999.9 1000 ... 999999	0.001 0.01 0.1 1
ISE [ $\mu$ mol/l]	0.000 ... 9.999 10.00 ... 99.99 100.0 ... 999.9 1000 ... 9999	0.001 0.01 0.1 1	
	[mmol/l]	1000 ... 999999	1
ISE [mg/kg]	0.000 ... 9.999 10.00 ... 99.99 100.0 ... 999.9 1000 ... 999999	0.001 0.01 0.1 1	
ISE [ppm]	0.000 ... 9.999 10.00 ... 99.99 100.0 ... 999.9 1000 ... 999999	0.001 0.01 0.1 1	
ISE [%]	0.000 ... 9.999 10.00 ... 99.99 100.0 ... 999.9 1000 ... 999999	0.001 0.01 0.1 1	
Manual temperature input	Parameter	Range	Increment
	T <sub>manual</sub> [°C]	- 20 ... + 130	1

## 14.2 General data

<b>Dimensions</b>	TruLab pH/ISE 1320:	Approx. 230 x 190 x 80 mm
	TruLab pH/ISE 1320 P:	Approx. 280 x 230 x 80 mm
<b>Weight</b>	TruLab pH/ISE 1320:	Approx. 0.8 kg
	TruLab pH/ISE 1320 P:	Approx. 1.0 kg
<b>Mechanical structure</b>	Type of protection	IP 43
<b>Electrical safety</b>	Protective class	III
<b>Test certificates</b>	CE, cETLus	
<b>Ambient conditions</b>	Storage	-25 °C ... +65 °C
	Operation	+5 °C ... +55 °C With the power pack connected: +5 °C ... +40 °C
	Admissible relative humidity	Yearly mean: < 75 % 30 days/year: 95 % Other days: 85 %
<b>Power supply</b>	Batteries	4 x 1.5 V alkali-manganese batteries, type AA
	Rechargeable batteries	4 x 1.2 V NiMH rechargeable batteries, type AA (no charging function)
	Operational life	Up to 1000 h without / 150 h with illumination
	Power pack	Kuantech Co. Ltd. KSAC 0900110W1UV-1 Input: 100 ... 240 V ~ / 50 ... 60 Hz / 270 mA Output: 9 V = / 1.1 A Connection max. overvoltage category II Primary plugs contained in the scope of delivery: Euro, US, UK and Australian.
<b>Sensor input</b>	Input resistance	> 5 * 10 <sup>12</sup> ohm
	Input current	< 1 * 10 <sup>-12</sup> A
<b>USB interface</b>	Type	USB 1.1 USB B (device), data output
	Baud rate	Adjustable: 1200, 2400, 4800, 9600, 19200 Baud
	Data bits	8
	Stop bits	2
	Parity	None
	Handshake	RTS/CTS
	Cable length	Max. 3 m



**Applicable directives  
and standards**

EMC	EC directive 2004/108/EC EN 61326-1 EN 61000-3-2 EN 61000-3-3 FCC Class A
Meter safety	EC directive 2006/95/EC EN 61010-1 UL 61010-1 CAN/CSA-C22.2#61010-1
IP protection class	EN 60529

**FCC Class A Equipment Statement**

*Note:* This equipment has been tested and found to comply with the limits for a Class A digital device, pursuant to Part 15 of the FCC Rules. These limits are designed to provide reasonable protection against harmful interference when the equipment is operated in a commercial environment. This equipment generates, uses, and can radiate radio frequency energy and, if not installed and used in accordance with the instruction manual, may cause harmful interference to radio communications. Operation of this equipment in a residential area is likely to cause harmful interference in which case the user will be required to correct the interference at his own expense. Changes or modifications not expressly approved by the manufacturer could void the user's authority to operate the equipment.

## 15 Firmware update

Available firmware updates are provided on the Internet.

With the firmware update program and a PC you can update the firmware of the TruLab pH/ISE 1320 to the newest version.

For the update you have to connect the meter to a PC.

For the update via the USB interface, the following is required:

- a free USB interface (virtual COM port) on the PC
- the driver for the USB interface (on the enclosed CD-ROM)
- the USB cable (included in the scope of delivery of the TruLab pH/ISE 1320).

1. Install the downloaded firmware update on a PC.  
An update folder is created in the Windows start menu.  
If an update folder already exists for the meter (or meter type), the new data is displayed there.
2. In the windows start menu, open the update folder and start the firmware update program.
3. Using the USB interface cable, connect the TruLab pH/ISE 1320 to a USB interface (virtual COM port) of the PC.
4. Switch on the TruLab pH/ISE 1320.
5. In the firmware update program, start the update process with OK.
6. Follow the instructions of the firmware update program.  
During the programming process, a corresponding message and a progress bar (in %) are displayed.  
The programming process takes approx. three minutes. A terminatory message is displayed after a successful programming process. The firmware update is completed.
7. Disconnect the TruLab pH/ISE 1320 from the PC.  
The TruLab pH/ISE 1320 is ready for operation again.

After switching the meter off and on you can check whether the meter has taken over the new software version (see YOU WANT TO KNOW WHICH SOFTWARE VERSION IS IN THE METER, PAGE 93).

## 16 Glossary

### pH/ORP/ISE

<b>Asymmetry</b>	see zero point
<b>Electromotive force of a electrode</b>	The electromotive force $U$ of the electrode is the measurable electromotive force of an electrode in a solution. It equals the sum of all the galvanic voltages of the electrode. Its dependency on the pH results in the electrode function, which is characterized by the parameters, slope and zero point.
<b>Junction</b>	The junction is a porous body in the housing wall of reference electrodes or electrolyte bridges. It arranges the electrical contact between two solutions and makes the electrolyte exchange more difficult. The expression, junction, is also used for ground or junction-less transitions.
<b>ORP voltage</b>	The ORP is caused by oxidizing or reducing substances dissolved in water if these substances become effective on an electrode surface (e. g. a gold or platinum surface).
<b>pH value</b>	The pH value is a measure of the acidic or basic effect of an aqueous solution. It corresponds to the negative decadic logarithm of the molal hydrogen ions activity divided by the unit of the molality. The practical pH value is the value of a pH measurement.
<b>Potentiometry</b>	Name of a measuring technique. The signal (depending on the measured parameter) of the electrode is the electrical potential. The electrical current remains constant.
<b>Slope</b>	The slope of a linear calibration function.
<b>Zero point</b>	The zero point of a pH electrode is the pH value at which the electromotive force of the pH electrode at a specified temperature is zero. Normally, this is at 25 °C.

### General information

<b>Adjusting</b>	To manipulate a measuring system so that the relevant value (e. g. the displayed value) differs as little as possible from the correct value or a value that is regarded as correct, or that the difference remains within the tolerance.
<b>AutoRange</b>	Name of the automatic selection of the measuring range.
<b>Calibration</b>	Comparing the value from a measuring system (e. g. the displayed value) to the correct value or a value that is regarded as correct. Often, this expression is also used when the measuring system is adjusted at the same time (see adjusting).
<b>Channel</b>	A channel is a display indication that corresponds to a physical connection on the meter.
<b>Measured parameter</b>	The measured parameter is the physical dimension determined by measuring, e. g. pH, conductivity or D.O. concentration.

---

<b>Measured value</b>	The measured value is the special value of a measured parameter to be determined. It is given as a combination of the numerical value and unit (e. g. 3 m; 0.5 s; 5.2 A; 373.15 K).
<b>Molality</b>	Molality is the quantity (in Mol) of a dissolved substance in 1000 g solvent.
<b>Reset</b>	Restoring the original condition of all settings of a measuring system.
<b>Resolution</b>	Smallest difference between two measured values that can be displayed by a meter.
<b>Stability control (AutoRead)</b>	Function to control the measured value stability.
<b>Standard solution</b>	The standard solution is a solution where the measured value is known by definition. It is used to calibrate a measuring system.
<b>Temperature function</b>	Name of a mathematical function expressing the temperature behavior of a test sample, a sensor or part of a sensor.
<b>Test sample</b>	Designation of the test sample ready to be measured. Normally, a test sample is made by processing the original sample. The test sample and original sample are identical if the test sample was not processed.

## 17 Index

### A

Automatic switch-off	20
AutoRead	
ORP	41, 43
pH	28, 45

### B

Battery compartment	12, 87
Blank value addition	64

### C

Calibration	
ISE	48
pH	31, 44
Calibration evaluation	
ISE	52
pH	38
Calibration interval	72
Calibration points	
pH	37
Connecting a PC	86

### D

Dataset	84
Date and time	25
Default settings	
Measured parameter	77
System settings	78
Display	18

### E

Energy saving mode	82
--------------------	----

### F

Firmware update	98
-----------------	----

### I

Initial commissioning	11
Initialize	77
Interval for calibration	72

### K

Keys	17
------	----

### M

Measured value display	21
Measurement accuracy	72

### Measurement data storage

Edit	82
Erase	82
Storage locations	84
Measurement dataset	84

### Measuring

ISE	45
ORP	43
ORP voltage	41
pH	28
Measuring method	54
Blank value addition	64
Sample addition	60
Sample subtraction	62
Standard addition	55
Standard subtraction	57

### Menus (navigation)

Messages	22
----------	----

### P

pH buffer sets	69
Print	85
Printer (only pH 7320P)	14

### R

Reset	77
-------	----

### S

Sample addition	60
Sample subtraction	62
Scope of delivery	11
Single-point calibration	
pH	32, 35
Slope	
ISE	48
pH	31
Socket field	19
Standard addition	55
Standard addition with blank	
value correction	64
Standard subtraction	57
Storage interval	80
Storing in memory	79
Automatic	80
Manual	79

**T**

Temperature measurement	
ISE	.47
pH	.30, 44
Three-point calibration	
ISE	.50
pH	.33, 36
Transmitting data	.85
Automatic	.85
Manual	.85
Transmitting measured values	.85
Two-point calibration	
ISE	.49
pH	.32, 35

**Z**

Zero point of pH combination electrode	. . .31
--	---------

## 18 Contact Information

### 18.1 Ordering & Technical Support

Telephone: (800) 897-4151  
(937) 767-7241  
Monday through Friday, 8:00 AM to 5:00 PM ET

Fax: (937) 767-1058

Email: [environmental@ysi.com](mailto:environmental@ysi.com)

Mail: YSI Incorporated  
1725 Brannum Lane  
Yellow Springs, OH 45387  
USA

Internet: [www.ysi.com](http://www.ysi.com)

When placing an order please have the following information available:

YSI account number (if available)	Name and Phone Number
Model number or brief description	Billing and shipping address
Quantity	Purchase Order or Credit Card

### 18.2 Service Information

YSI has authorized service centers throughout the United States and Internationally. For the nearest service center information, please visit [www.ysi.com](http://www.ysi.com) and click 'Support' or contact YSI Technical Support directly at 800-897-4151.

When returning a product for service, include the Product Return form with cleaning certification. The form must be completely filled out for an YSI Service Center to accept the instrument for service. The Product Return form may be downloaded at [www.ysi.com](http://www.ysi.com) and clicking on the 'Support' tab.







# Xylem |'zīləm|

- 1) The tissue in plants that brings water upward from the roots;
- 2) a leading global water technology company.

We're 12,500 people unified in a common purpose: creating innovative solutions to meet our world's water needs. Developing new technologies that will improve the way water is used, conserved, and re-used in the future is central to our work. We move, treat, analyze, and return water to the environment, and we help people use water efficiently, in their homes, buildings, factories and farms. In more than 150 countries, we have strong, long-standing relationships with customers who know us for our powerful combination of leading product brands and applications expertise, backed by a legacy of innovation.

**For more information on how Xylem can help you, go to [www.xylem.com](http://www.xylem.com)**



a **xylem** brand

YSI  
1725 Brannum Lane  
Yellow Springs, OH 45387  
Tel: +1 937-767-7241; 800-765-4974  
Fax: +1 937-767-1058  
Email: [environmental@ysi.com](mailto:environmental@ysi.com)  
Web: [www.ysi.com](http://www.ysi.com)

©Xylem Inc